



SD8161

Speed Dome Network Camera

1080p Full HD · 18x Zoom · PoE Plus

VIVOTEK's SD8161 is part of the SUPREME series product line offering 1080p Full HD resolution with superb image quality. Adopting a 18x optical zoom lens and sophisticated pan/tilt mechanism, the SD8161 is able to capture fine detail at top-notch quality, and is especially suitable for wide open indoor spaces such as airports and lobbies where highest levels of reliability and precision are always required.

The SD8161 supports high-performance H.264/MJPEG compression technology and offers extra smooth video quality with resolution of up to 30 fps @ 1080p. With WDR Enhancement technology, the SD8161 can also cope with challenging lighting conditions and generate image quality close to the capabilities of the human eye. With a sophisticated pan/tilt mechanism, the camera provides fast, precise movement with continuous 360-degree pan and 220-degree tilt. Users can also easily control the lens position via a mouse or a joystick to track the object of interest and set up to 256 preset positions. With its built-in auto tracking feature, the SD8161 further provides instantaneous reaction to suspicious moving objects in wide area locations, even before operators are aware of activity. With other advanced features such as MicroSD/SDHC/SDXC card slot, 802.3at compliant PoE Plus and 30 fps high quality video, the SD8161 is the best choice for the most demanding indoor surveillance applications.

Key Features

- 2-Megapixel CMOS Sensor
- 30 fps @ 1920 x 1080
- 18x Zoom Lens
- Real-time H.264 and MJPEG Compression
- WDR Enhancement for Unparalleled Visibility in Extremely Bright and Dark Environments
- Audio Detection for Instant Alerts
- Auto Tracking for Moving Objects
- Built-in 802.3at Compliant PoE Plus
- 3D Privacy Masks for Additional Protection
- Built-in MicroSD/SDHC/SDXC Card Slot for On-board Storage



Full HD 1X



Full HD 18X



Airports

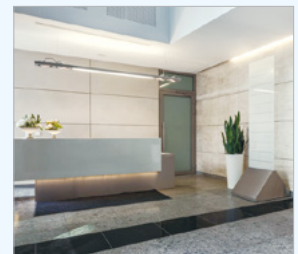

Lobby

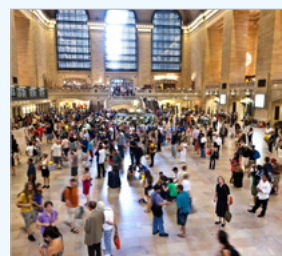

Train Station



Shopping Mall

Technical Specifications







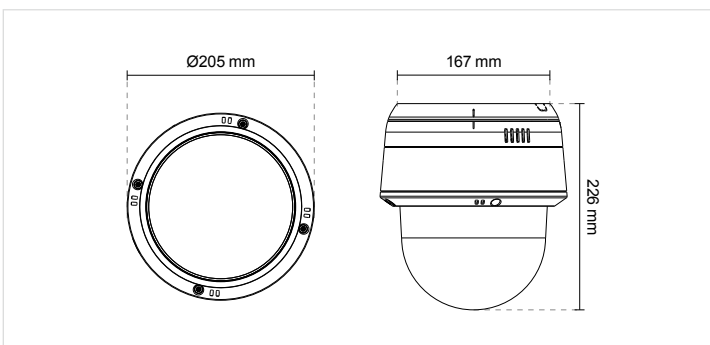



Model	SD8161
System Information	
CPU	Multimedia SoC (System-on-Chip)
Flash	256 MB
RAM	512 MB
Camera Features	
Image Sensor	1/3" Progressive CMOS
Maximum Resolution	1920x1080
Lens Type	18x Optical Zoom, Auto Focus
Focal Length	f = 4.7 ~ 84 mm
Aperture	F1.6 ~ F2.8
Auto-iris	DC-iris
Field of View	4° ~ 61° (Horizontal) 2° ~ 36° (Vertical) 5° ~ 70° (Diagonal)
Shutter Time	1/5 sec. to 1/32,000 sec.
WDR Technology	WDR Enhanced
Day/Night	Removable IR-cut filter for day & night function
Minimum Illumination	0.72 Lux @ F1.6 (Color) 0.001 Lux @ F1.6 (B/W)
Pan Speed	0.05° ~ 450° / sec
Pan Range	360 endless
Tilt Speed	0.05° ~ 450° / sec
Tilt Range	220° (-110° ~ +110°)
Preset Locations	256 preset locations, 40 presets per tour
Pan/tilt/zoom Functionalities	48x digital zoom (4x on IE plug-in, 12x built-in) Auto pan mode Auto patrol mode
On-board Storage	MicroSD/SDHC/SDXC card slot
Video	
Compression	H.264, MJPEG
Maximum Frame Rate	30 fps @ 1920x1080 In both compression modes
Maximum Streams	4 simultaneous streams
S/N Ratio	Above 67dB
Dynamic Range	60dB
Video Streaming	Adjustable resolution, quality and bitrate Zoom enhancement for better image quality under limited bandwidth
Image Settings	Adjustable image size, quality and bit rate Time stamp, text overlay, flip & mirror Configurable brightness, contrast, saturation, sharpness, white balance, exposure control, gain, backlight compensation, privacy masks (Up to 24) Scheduled profile settings, 3D Noise Reduction
Audio	
Audio Capability	Audio input/output (full duplex)
Compression	AAC, G.711, G.726
Interface	External microphone input External line output
Network	
Users	Live viewing for up to 10 clients
Protocols	IPv4, IPv6, TCP/IP, HTTP, HTTPS, UPnP, RTSP/RTP/RTCP, IGMP, SMTP, FTP, DHCP, NTP, DNS, DDNS, PPPoE, CoS, QoS, SNMP, 802.1X
Interface	10Base-T/100 BaseTX Ethernet (RJ-45)
ONVIF	Supported, specification available at www.onvif.org

Intelligent Video	
Video Motion Detection	Triple-window video motion detection
Auto-Tracking	Auto-tracking on moving object
Alarm and Event	
Alarm Triggers	Video motion detection, manual trigger, digital input, periodical trigger, system boot, recording notification, camera tampering detection, audio detection
Alarm Events	Event notification using digital output, HTTP, SMTP, FTP and NAS server File upload via HTTP, SMTP, FTP and NAS server
General	
Connectors	RJ-45 cable connector for Network/PoE connection Audio input Audio output AC 24V power input DC 12V power input Digital input*4 Digital output*2 RS-485 for PTZ control (PelcoD protocol, adjustable baud rate 2400~19200)
LED Indicator	System power and status indicator
Power Input	PoE plus (IEEE 802.3at compliant) DC 12V AC 24V
Power Consumption	PoE Plus: Max. 25.5W AC24V/DC12V: Max. 30W
Dimensions	Ø: 205 mm x 226 mm
Weight	Net: 2330 g
Safety Certifications	CE, FCC Class B, VCCI, C-tick, UL
Operating Temperature	Starting Temperature: 0°C ~ 50°C (32°F ~ 122°F) Working Temperature: -10°C ~ 50°C (14°F ~ 122°F)
Warranty	36 months
System Requirements	
Operating System	Microsoft Windows 7/Vista/XP/2000
Web Browser	Mozilla Firefox 7-10 (Streaming only) Internet Explorer 7/8/9/10
Other Players	VLC: 1.1.11 or above Quicktime: 7 or above
Included Accessories	
CD	User's manual, quick installation guide, Installation Wizard 2, ST7501 32-channel recording software
Others	Ceiling mount bracket, screws, terminal blocks, quick installation guide, warranty card, alignment sticker, T25 stardriver, software CD

Dimensions



Compatible Accessories

Mounting Kits			PoE Solution						
	AM-116/117 20/40 cm pendant pipe		AM-118 Indoor pendant head		AM-221 Goose neck mounting kit		AM-104 Recessed Kit		AW-FET-050A-065 4-port Unmanaged PoE Switch
	AM-231 Parapet mounting kit		AM-519 1.5" PT adapter		AM-521 Mounting adapter		AC-214 Smoked cover		AP-GIC-010A-030 1xGE IEEE 802.3at PoE Injector
Others									

All specifications are subject to change without notice. Copyright © VIVOTEK INC. All rights reserved.

Ver. 5