



IP816A-LPC Kit

License Plate Capture Solution

Dual Lanes · Headlight Filter · 60MPH (90KM/H) · Scene Overview · Recognition Distance 20M · Remote Back Focus · EIS

VIVOTEK IP816A-LPC Kit represents a total solution for LPC (License Plate Capture) applications by leveraging the top-notch quality and traffic monitoring ability of the IP816A-HP. With the adoption of built-in corresponded IR LEDs and an IR pass filter, the IP816A-LPC Kit delivers clear license plate images for reliable recognition, in both the highest levels of glare, and in the darkest hours of the night.

Empowered with VIVOTEK Scene Mode, which provides different exposure levels to avoid overexposure in some lighting conditions, the IP816A-LPC Kit can capture clear plate images from the vehicles moving at speeds of up to 90km/h.

Value-added features such as EIS (Electronic Image Stabilization) and VIVOTEK Snapshot Focus ensure that the IP816A-LPC Kit can be easily installed and adjusted to provide the perfect LPR solution. Further, with the high-resolution images supporting a wide range of up to two lanes, the IP816A-LPC Kit is also the most economic solution in LPR applications.

Key Features

- Scene Overview and LPC View in One Camera
- Dedicated Design Provides Stable and Reliable 24/7 & Day/Night Performance for Traffic Monitoring
- Specific Exposure Design to Avoid Overexposure and Glare
- Headlight Filter for Brilliant Night Image
- Wide Coverage for Dual Lanes
- Vandal-Proof IK10-rated and Weather-Proof IP66-rated Housing
- Value-Added Features Including VIVOTEK Snapshot Focus, RBF, and EIS to Support Traffic Monitoring Applications



Scene Overview and LPC View in One Camera

VIVOTEK's 2 Mega-pixel resolution kit provides not only sufficient PPF for license plate capture, but also for a clear overview of moving vehicles, including car color, brand and type for general traffic surveillance purposes. Therefore, with only one VIVOTEK IP816A-LPC Kit, users can yield more information from one single location.



Scene Overview



License Plate Recognition View

Headlight Filter Design

Capturing images at night is a challenging issue for any surveillance application, but for License Plate Capture applications the challenge is even greater due to noise and glare caused by the headlights of cars. The IP816A-LPC Kit is equipped with external 24W IR LEDs and a delicate IR Pass Filter, which help to filter out reflected light and only capture detailed information from the plates. Moreover, the IR threshold is also programmed to deploy the IR LED automatically to ensure 24/7 & Day/Night performance.

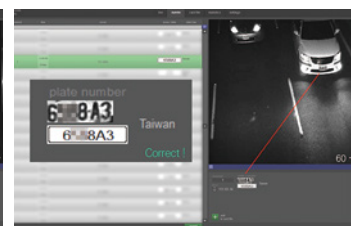
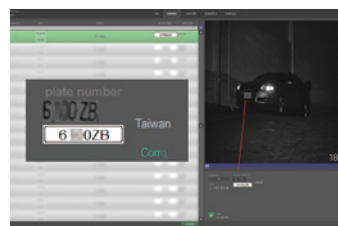

Clear Image Captured with IR LEDs and IR Pass Filter

One Camera to Cover Dual Lanes

The high image quality of the IP816A-LPC Kit ensures wide coverage of two lanes with one Camera, whether used for street monitoring or for parking lot monitoring. With a single IP816A-LPC Kit covering dual lanes, the total cost of traffic monitoring will be reduced.

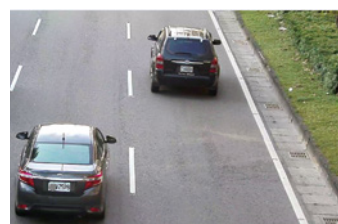

Day Time

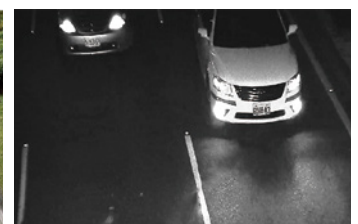

Night Time

Suggested Installation

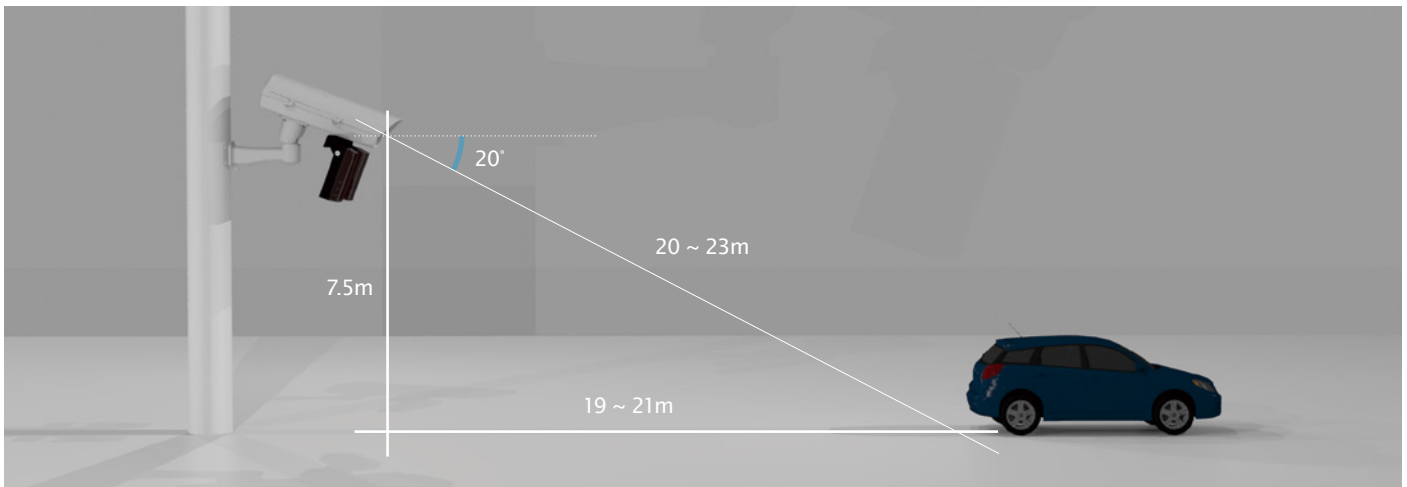

Ordering Information

IP816A-LPC Kit P/N: 199001000G		
Category	Model	Description
IP Camera	IP816A-LPC (40mm)	2MP, 60fps, WDR Pro, Remote Back Focus, 3DNR, EIS, Snapshot
IR LED	AI-104-010	-40°C ~ 50°C, 24W IR LED, 10°, 100m, IK10, IP66, 12~24VDC or 24VAC in
Enclosure	AE-237	Outdoor Enclosure with -20°C ~ 50°C, Anti-Icing Heated Glass, Fan, 24V AC in, IP66, IK10
Bracket	AM-219	IR Bracket

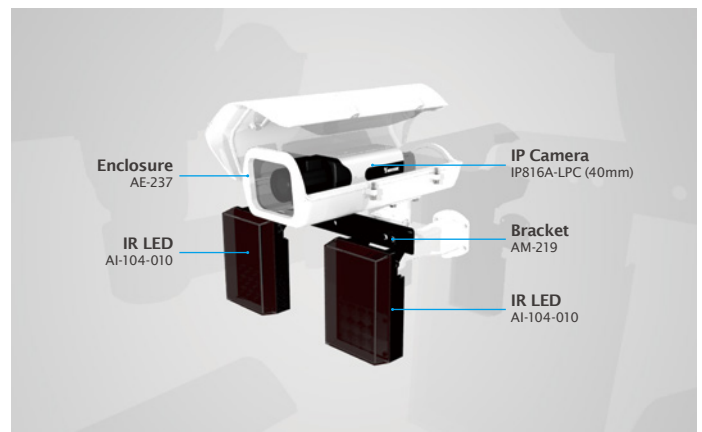

Mechanical Information

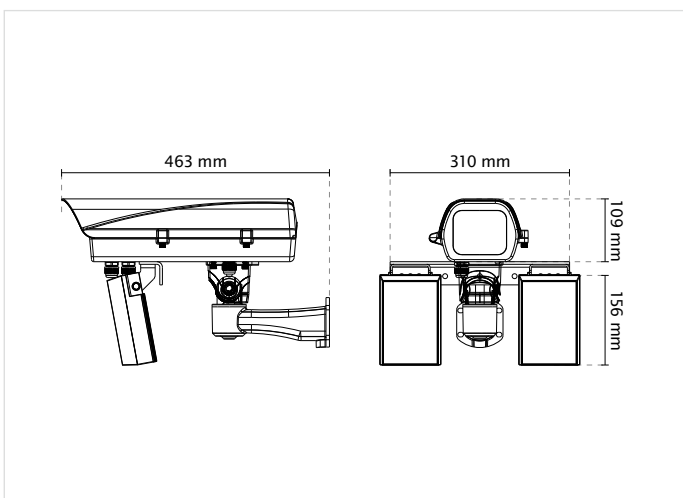

IP816A-LPC Kit Specification

Model	IP816A-LPC Kit	Interface	10Base-T/100BaseTX Ethernet (RJ-45) *It is highly recommended to use standard Cat. 5e & Cat. 6 cables which are compliant with the 3P/ETL standard.
Max. Speed	60MPH (90 km/h)	ONVIF	Supported, specification available at www.onvif.org
IR Threshold	IR on: 300 Lux IR off: 600 Lux	Intelligent Video	
Shutter Time	1/800 to 1/10,000 sec.	Video Motion Detection	Triple-window video motion detection
Max. Shutter Time	1/5 to 1/10,000 sec.	Alarm and Event	
IR Illuminators	24 W, 10' x 2	Alarm Triggers	Video motion detection, manual trigger, digital input, periodical trigger, system boot, recording notification, camera tampering detection, audio detection, IR Status
Capture Range	Up to 20 m	Alarm Events	Event notification using digital output, HTTP, SMTP, FTP and NAS server, SD Card File upload via HTTP, SMTP, FTP, NAS server and SD card
Captured Lanes	Dual Lanes	General	
Power Input	AC 24V	Smart Focus System	RBF (Remote Back Focus)
Power Consumption	Max. 77.4 W (AC 24V) Suggested Power: AC 24V / 3.5A	IP Camera Connectors	RJ-45 for Network/PoE connection AC 24V power input Digital input*3 Digital output*1
Weight	5,222 g	Safety Certifications	IP Camera : CE, LVD, FCC Class B, VCCI, C-Tick, UL
Housing	Weather-proof IP66-rated housing Vandal-proof IK10-rated housing	Warranty	36 months
Operating Temperature	Starting Temperature: 0°C ~ 50°C (32°F ~ 122°F) Working Temperature: -10°C ~ 50°C (14°F ~ 122°F) Humidity: 90%	System Requirements	
Video		Operating System	Microsoft Windows 8/7/Vista/XP/2000
Compression	H.264 & MJPEG	Web Browser	Mozilla Firefox 7 ~ 10 (streaming only) Internet Explorer 7/8/9/10/11
Maximum Streams	2 simultaneous streams	Other Players	VLC: 1.1.11 or above QuickTime: 7 or above
Image Settings	Time stamp, text overlay, flip & mirror; Configurable brightness, contrast, saturation, sharpness, white balance, exposure control, gain, backlight compensation, privacy masks, scheduled profile settings; 3D noise reduction, EIS, video rotation, snapshot focus, scene mode		
Network			
Users	Live viewing for up to 10 clients		
Protocols	IPv4, IPv6, TCP/IP, HTTP, HTTPS, UPnP, RTSP/RTP/RTCP, IGMP, SMTP, FTP, DHCP, NTP, DNS, DDNS, PPPoE, CoS, QoS, SNMP, 802.1X, UDP, ICMP, ARP, SSL, TLS		

Network Camera - Technical Specifications

Model	IP816A-LPC (40mm)	Field of View	10.2° ~ 30° (Horizontal) 8° ~ 22° (Vertical) 12° ~ 38° (Diagonal)
CPU	Multimedia SoC (System-on-Chip)	WDR Technology	WDR Pro (Default: Off)
Flash	256 MB	Day/Night	Removable IR-cut filter for day & night function
RAM	384 MB	Pan/Tilt/Zoom Functionalities	ePTZ: 48x digital zoom (4x on IE plug-in, 12x built in)
Camera Features		On-board Storage	SD/SDHC/SDXC card slot
Image Sensor	1/1.9" Progressive CMOS	Video	
Maximum Resolution	1920x1080 (2MP)	Maximum Frame Rate	30fps @ 1920x1080 60fps @ 1920x1080 (In one-stream mode only) (In both compression mode)
Lens Type	Vari-focal	S/N Ratio	50.8 dB
Focal Length	f = 12 ~ 40 mm	Dynamic Range	100 dB
Aperture	F2.36 ~ F2.44		
Auto-iris	P-iris		

IR LED - Technical Specifications

Model	AI-104-010	Operating Temperature	-40°C ~ 50°C (-40°F ~ 122°F)
Max. Distance	100 m	Color	Black
Beam Angle	10°	Wavelength	850nm
Input Power	24V AC 12 to 24V DC	Dimensions	157 (D) x 105 (W) x 81 (H) mm
Power Consumption	24W	Included Accessories	U-bracket
Weight	0.85 kg	Certifications	CE, FCC, VCCI, C-TICK
Housing	Weather-proof IP66-rated housing Vandal-proof IK10-rated housing	Integrated Control	Built-in photocell for automatic IR on/off

All specifications are subject to change without notice. Copyright © VIVOTEK INC. All rights reserved.

Ver. 21



VIVOTEK INC.
6F, No.192, Lien-Cheng Rd., Chung-Ho,
New Taipei City, 235, Taiwan, R.O.C.
T: +886-2-82455282 F: +886-2-82455532
E: sales@vivotek.com

VIVOTEK USA
2050 Ringwood Avenue,
San Jose, CA 95131
T: 408-773-8686 F: 408-773-8298
E: salesusa@vivotek.com

VIVOTEK Europe
Randstad 22-133, 1316BW Almere,
The Netherlands
T: +31(0)36-5298-434
E: saleseurope@vivotek.com

VIVOTEK India
602, Best sky Tower, Plot No. F-5,
Netaji Subhash Place, Pitam Pura, Delhi-110 034
T: +91-11-45137465
E: salesindia@vivotek.com