

CAM3365

3 Megapixel Day&Night WDR Bullet Camera



- 3 Megapixel SONY Low Light Sensor
- Up to 2048 x 1536 Video Resolution
- Surveon Video Intelligent Ready
- 3X Optical Zoom and Surveon Auto Focus
- PoE (IEEE 802.3af) and Day/Night ICR
- Built-in IR Illuminators, Effective Up to 30 Meters
- IP66 and Wide Temperature for Outdoor Application



Product Specification

Camera	
Image sensor	1/2.8" 3 megapixel SONY low light CMOS
Lens	3 - 10 mm motor lens, F1.3
WDR	Yes (70 dB)
Day/Night ICR	Yes
IR LED	Yes (20M)
Min illumination	0.1 Lux @ F1.2, 0 Lux (IR LEDs on)
Iris control	DC drive
Shutter time	1/5 ~ 1/15,000 s
Viewing angle	Diagonal: 129°~34° Horizontal: 100°~27° Vertical: 73°~20°
Camera angle adjustment	N/A
Pan/tilt/zoom functionalities	N/A
Video	
Video compression	H.264/MPEG-4/MJPEG
Resolution	Up to 2048 x 1536
Frame rate	15 fps at QXGA (2048 x 1536), 25 fps at 1080P (1920 x 1080), 30 fps at SXGA (1280 x 1024), 30 fps at HD720 (1280 x 720), 30 fps at VGA (640 x 480), 30 fps at QVGA (320 x 240)
Video stream	Dual stream at H.264, MPEG-4, and MJPEG simultaneously
Bit rate	32K ~ 10Mbps, VBR, CBR, controller frame rate and quality
Video control	AGC (Auto Gain Control), AWB (Auto White Balance), BLC (Back Light Compensation), image adjustment
Surveon Video Intelligent	Motion detection, tampering detection (blocked, redirected, defocused, or spray-painted), missing object, foreign object, intrusion detection, forbidden area
Video jack	N/A
Audio	
Built-in MIC	N/A

Audio compression	32KHz, ADPCM
Audio input/output	3.5mm phone jack
I/O and Event Management	
Alarm in	2, terminal block
Alarm out	1, terminal block
Video buffer	5 second pre-alarm, 30 second post-alarm
Event action	Send snapshot or video clip by FTP or email, record to NAS, record to local storage, trigger DO
Network	
Supported protocols	IPv4, ARP, TCP, UDP, ICMP, DHCP, NTP, DDNS, SMTP, FTP, HTTP, CIFS, PPPoE, UPnP, RTP, RTSP, RTCP, 3GPP
Ethernet	10/100 Base-T / RJ45
System	
Local storage	microSD/SDHC x 1 (Class 4/Class 6 only)
RS-485	1 (2 pin on terminal block)
USB	N/A
SDK	Surveon SDK 2.0
Viewing System	
OS	Microsoft Windows XP/Vista/7
Browser	Microsoft IE 6.0 or above
Software	VMS 2.4.1
General	
Temperature	Operation: -25°C~ 50°C (-4°F~122°F) Storage: -30°C ~ 60°C (-22°F~140°F)
Humidity	5 to 90%
Power	12VDC 1.5A ; PoE (IEEE 802.3af) with Class 3
Power consumption	Max. 8W (w/o Heater) Max. 13W (w/ Heater)
Dimension	105mm x 218.8mm x 191.41mm (3.44" x 7.18" x 6.28")
Weight	Net:1,400g (3.09lb.) Gross:2,170g (4.8lb.)
Certification	Safety: LVD EMC: FCC, CE IP66

* All specifications are subject to change without notice.
* All brand names and registered trademarks are the property of their respective owners.

CAM3365

3 Megapixel Day&Night WDR
Bullet Camera

Part Names and Functions

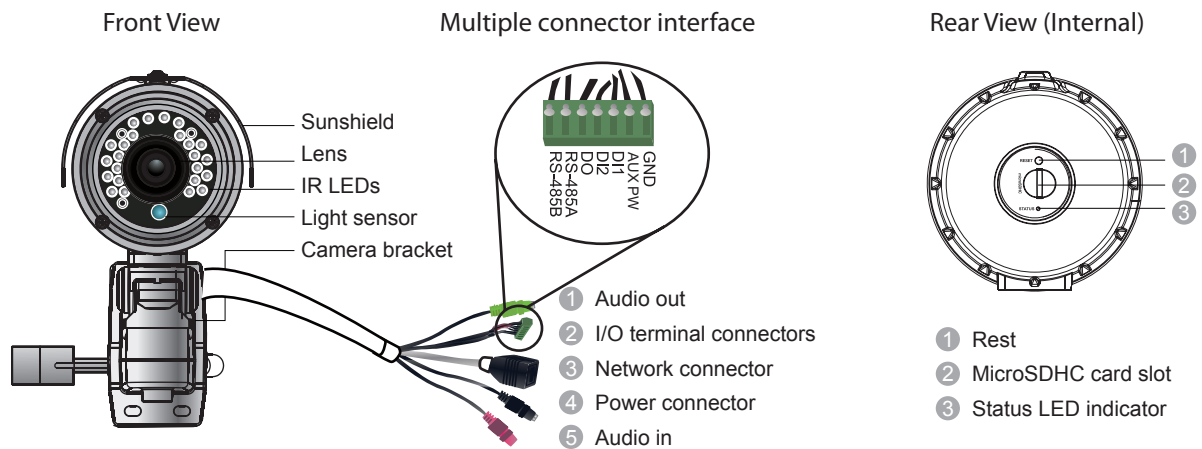

Appearance

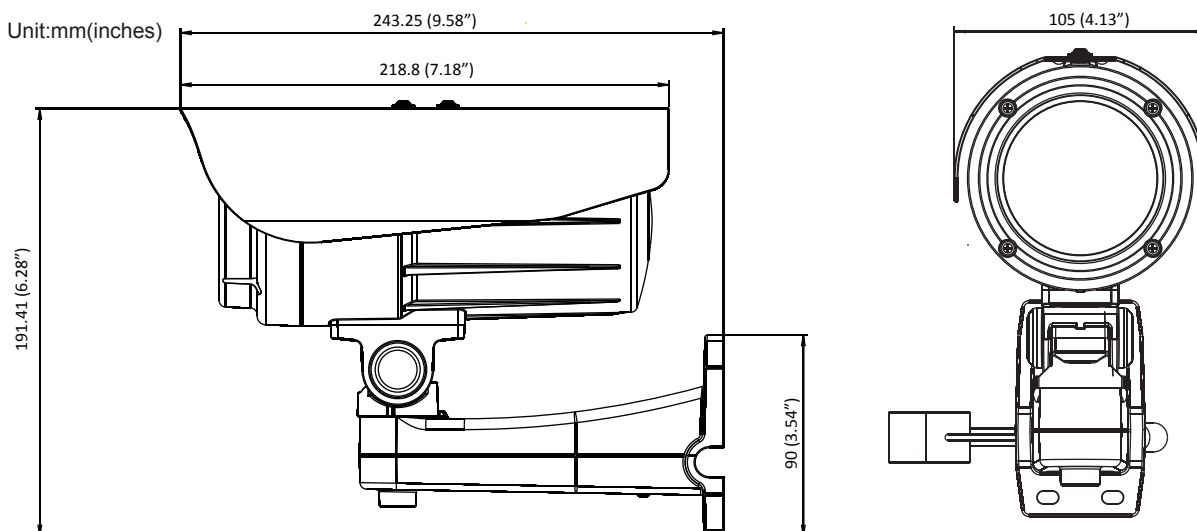

Package Content

Contents	Quantity
Quick Installation Guide	1
Product DVD	1
CAM3365	1
Camera Bracket	1
Screw Hole Indicator Sticker	1
Anchors and Mounting Screws	4
L Type Hexagon Spanner	1

Ordering Information

Part Number	Description
CAM3365-0055	3 megapixel day&night outdoor bullet network camera with motor lens

Optional Accessories

Part Number	Description
ZPWR18W-0030	Power Adapter
CAM3365-0050	CAM3365 with Power Adapter