

DS-TMG423**Barrier Gate with Fence Boom Pole**

- Adopts integrated machine core. Parallel gear decelerates linkage arm transmission to ensure stability and efficiency.
- Supports convenient side installation with compact structure.
- Adopts quenching process for carbon steel gear to realize wear-resistant and impact-resistant functions and extend product life.
- Adopts small DC brushless motor with low noise to increase output torque and realize precise intelligent control.
- Supports rebound for obstacle and opening priority.
- Adopts DC variable frequency control to enable smooth operation with fast boom pole opening and slow boom pole closing.
- Supports event log to enable convenient monitoring.
- Supports multiple anti-fall modes such as IR, vehicle detectors, and radars.
- Supports fault code detection on the nixie tube, log record, and abundant status indicating. Based on the fault code displayed on the nixie tube, you can realize quickly problems locating and maintenance.
- Supports manually opening boom pole. You can turn hand wheel to keep barrier gate opening during power cutoff.
- Delayed boom pole closing (10 s delay time by default). Supports 99 shifts (initial status 2 s, 2 s gap between each shift).
- Supports auto boom pole opening during power cutoff. The barrier gate can open automatically to allow fire trucks in (optional components required).

▪ Specification

Barrier Housing	
Barrier Housing Material	SGCC
Barrier Housing Thickness	1.5 mm
Barrier Housing Door Thickness	1.2 mm
Barrier Housing Color	Iron gray
Barrier Housing Door Color	Orange red
Boom Pole Installation Height	885 mm
Body Indicators	DS-TMG423, DS-TMG423-L, DS-TMG423-R: No body indicator DS-TMG423/B, DS-TMG423-L/B, DS-TMG423-R/B: With body indicator. Green: arrow indicator. Red: passing prohibition indicator.
Barrier Gate General	
Rising/Falling Speed	4m fence pole Rising Speed: 3 S Falling Speed: 3 S
Boom Pole Direction	DS-TMG423-L: Left DS-TMG423-R: Right
Motor Type	DC brushless motor
Matched Boom Pole Type	Fence boom pole
Boom Pole Falling Delay	10 s by default (configurable), min. 2 s (every 2 s followed a gap)
Number of Cycles	5,000,000
Working Voltage	220 VAC
Consumption	DS-TMG423-L, DS-TMG423-R: Max. 168 W DS-TMG423-L/B, DS-TMG423-R/B: Max. 176 W
Temperature and Humidity	Temperature: -30 °C to 60 °C (-22 °F to 140 °F), Humidity: ≤ 90%
Rising Boom Pole for Poweroff	Optional, not supported by default
Package	
Barrier Housing Dimensions (L × W × H)	1060 × 370 × 262 mm (41.73 × 14.57 × 10.31 inch)
Body Weight	43 ± 3 kg (94.8 ± 6.61 lb.)
Body Dimensions (with Package, Without Boom Pole) (L × W × H)	1266 × 504 × 626 mm (49.84 × 19.84 × 24.65 inch)
Body Weight (with Package, Without Boom Pole)	47 ± 3 kg (103.61 ± 6.61 lb.)
Barrier Gate	
Duty Cycle	100%
Interface	
RS-485	1 group
Rising to Limit	1 group
Falling to Limit	1 group
Open	1 group
Close	1 group
Stop	1 group
IR/Vehicle Detector/Radar	1 group
Traffic Signal Light	1 group, external power supply required, max. 220 VAC supported

Approval	
RF	CE-RED EN 300220-1 V3.1.1 EN 300220-2 V3.1.1 EN 301489-1 V2.2.3 EN 301489-3 V2.1.1 EN IEC 62311: 2020
EMC	CE-EMC: EN 55032: 2015/A11: 2020 + A1: 2020, EN IEC 61000-3-2: 2019/A1: 2021, EN 61000-3-3: 2013 + A1: 2019/A2: 2021, EN 50130-4: 2011+A1: 2014
Security	CE-LVD: EN 62368-1: 2014/A11: 2017 CB: IEC 62368-1: 2014 IEC 62368-1: 2018
Environment	ROHS
Protection	IP54, IK09
Boom Pole	
Boom Pole Color	White background with red bar
Boom Pole Weight	3 m: 7.8 ± 0.3 kg (8.33 ± 0.66 lb.) 4 m: 9.65 ± 0.3 kg (21.27 ± 0.66 lb.) 2.5 + 2.5 m: 11.75 ± 0.3 kg (25.9 ± 0.66 lb.)
Boom Pole Dimensions (with Package)	3 m: 250 × 90 × 3280 mm (9.84 × 3.54 × 129.13 inch) 4 m: 230 × 90 × 4300 mm (9.06 × 3.54 × 169.29 inch) 5 m: 140 × 90 × 5260 mm (5.51 × 3.54 × 207.09 inch)
Boom Pole Weight (with Package)	3 m: 9.56 ± 0.3 kg (21.07 ± 0.66 lb.) 4 m: 11.34 ± 0.3 kg (25 ± 0.66 lb.) 5 m: 13.64 ± 0.3 kg (30.07 ± 0.66 lb.)
Boom Pole Dimensions	3 m: 1261.5 × 92.5 × 3000 mm (49.67 × 3.64 × 118.11 inch) 4 m: 1261.5 × 92.5 × 4000 mm (49.67 × 3.64 × 157.48 inch) 5 m: 1261.5 × 92.5 × 5000 mm (49.67 × 3.64 × 196.85 inch)
Boom Pole Material	AL6061

▪ Available Model

DS-TMG423-L(4m)

DS-TMG423-R(4m)

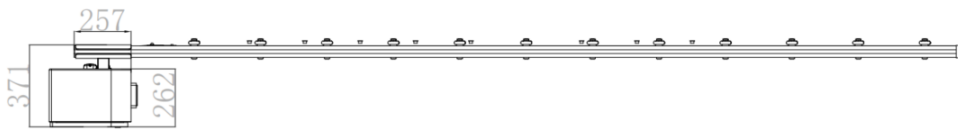
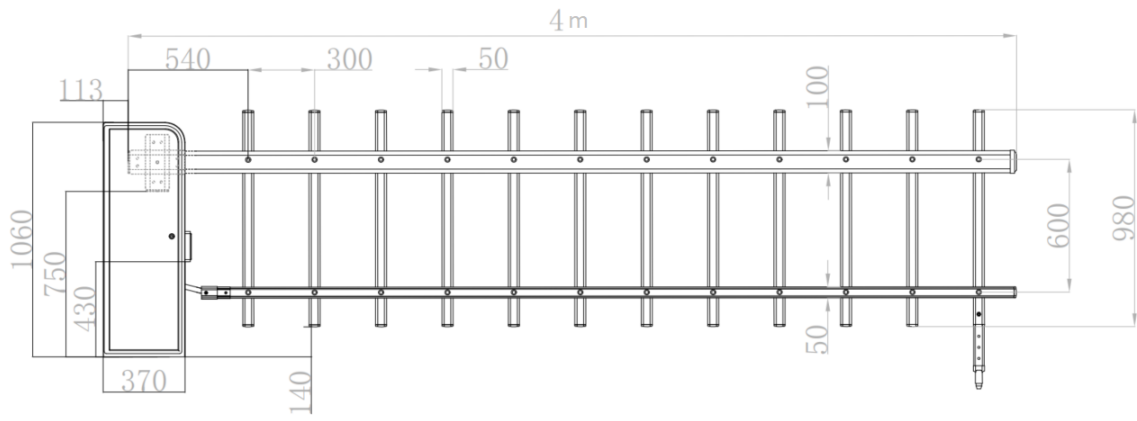
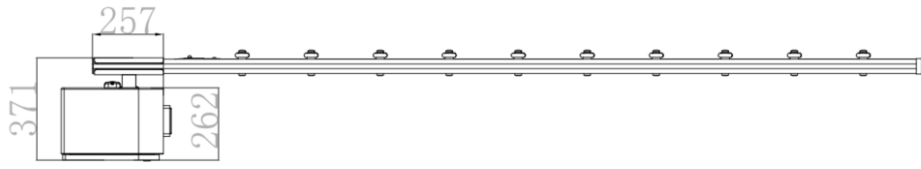
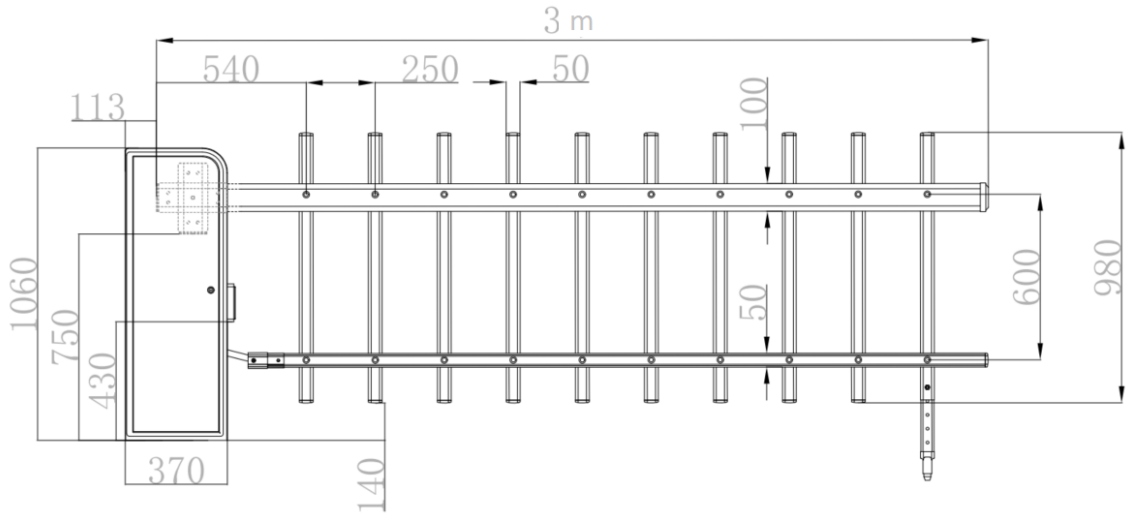

▪ Dimension

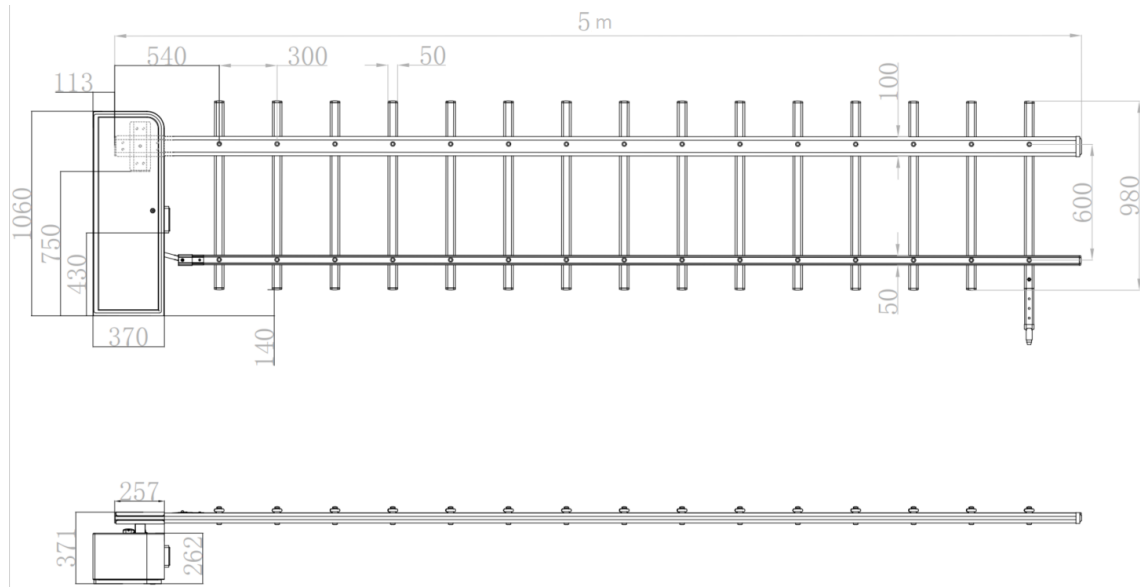





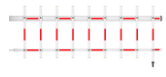





▪ **Accessory**

▪ **Included**

DS-TMG004-5 Fence Boom Pole	DS-TMG012-5 Remote Controller
	

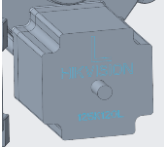
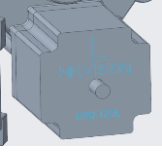
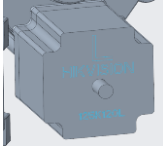
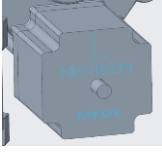
▪ **Optional**

<p>TMG080-3 TMG080-3</p>	<p>DS-TMG070/4B/42(24V) Barrier Gate Indicator</p>	<p>DS-TMG060-42 Barrier Gate Supercapacitor Board</p>	<p>DS-TMG050 Pull Rod Antenna Assembly</p>	<p>DS-TMG000-2-L(lo w speed)</p>
------------------------------	---	---	--	--------------------------------------

				
<p>DS-TMG000-2-L (high speed)</p>	<p>DS-TMG000-2-R (low speed)</p>	<p>DS-TMG000-2-R (high speed)</p>	<p>DS-TMG022 Coil Vehicle Detector</p>	<p>DS-TMG023 Coil</p>
				
<p>DS-TVL221-1-6D Entrance & Exit Signal Light</p>				
				

Headquarters

No.555 Qianmo Road, Binjiang District,
Hangzhou 310051, China
T +86-571-8807-5998
www.hikvision.com



Follow us on social media to get the latest product and solution information.

