

XNF-9010RVM

12MP IR Fisheye Camera – Mobile exclusive



Key Features

- 1/2.3" 12MP CMOS
- 1.08mm fixed focal lens
- Stereo graphic type lens, enhanced resolution for the peripheral regions
- H.265, H.264, MJPEG codec supported
- Fisheye, Single panorama, Double panorama, Quad view
- On board dewarping, Digital PTZ
- extreme WDR (120dB), WiseStream II support
- Wise IR, IR viewable length 10m
- Virtual channel support
- Plugin support, selectable I/O port
- Video Analytics, Heatmap, People counting
- Queue management
- Hard coated dome cover
- Motion detection, Handover, IP66/IK10/NEMA4X
- Mobile certified, RJ45 – M12 ethernet connector included

Video	
Imaging Device	1/2.3" 12MP CMOS
Resolution	Original view(1:1): 3008x3008~480x480, Double panorama(2:1): 3584x1792~640x320, Single panorama(4:1): 3584x896~640x160, Quad view: 3584x2688~640x480, Q1/Q2/Q3/Q4(4:3): 1792x1344~640x480
Maximum Framerate	H.265/H.264: Original view-Max.30fps/25fps@3008x3008, Double panorama-Max.30fps/25fps@3584x1792 Single panorama-Max.30fps/25fps@3584x896 MJPEG: Max.30fps/25fps@1080x1080
Minimum Illumination	Color: 0.39 Lux (F2.2, 1/30sec), BW : 0Lux (IR LED on)
Video Out	CVBS : 1.0 Vp-p / 75Ω composite, 720x480, for Installation USB: Micro USB Type B, 1280x720 for installation

Lens	
Focal Length (Zoom Ratio)	1.08mm fixed focal
Maximum Aperture Ratio	F2.2
Angular Field of View	H: 187° / V: 187° / D: 187°
Minimum Object Distance	0.5m(1.64ft)
Focus Control	Simple focus

Operational	
Camera Title	Displayed up to 85 characters
Day & Night	Auto(ICR)
Backlight Compensation	BLC, HLC, WDR, SSSDR
Wide Dynamic Range	extremeWDR (120dB)
Digital Noise Reduction	SSNRV
Motion Detection	8ea, 8point polygonal zones
Privacy Masking	32ea, polygonal zones - Color: Grey/Green/Red/Blue/Black/White - Mosaic
Gain Control	Low / Middle / High
White Balance	ATW / Narrow ATW / AWC / Manual / Indoor / Outdoor
Electronic Shutter Speed	Minimum / Maximum / Anti flicker (1/5~1/12,000sec)
Video Rotation	Flip, Mirror
Analytics	Defocus detection, Directional detection, Motion detection, Appear/Disappear, Enter/Exit, Loitering, Tampering, Virtual line, Audio detection, Sound classification
Business Intelligence	People counting, Queue management, Heatmap
Alarm I/O	2 configurable I/O
Alarm Triggers	Analytics, Network disconnect, Alarm input

Alarm Events	File upload via FTP and e-mail Notification via e-mail SD/SDHC/SDXC or NAS recording at event triggers Alarm output PTZ Preset Handover Audio playback
Audio In	Selectable (microphone in/line in/built-in microphone) Supply voltage: 2.5VDC(4mA), Input impedance: 2K Ohm
Audio Out	Line out, Maximum output level: 1Vrms
IR Viewable Length	10m(32.8ft), Wise IR
Network	
Ethernet	Metal shielded M12, female, D-coded, Mode A (with included RJ45 to M12 cable)
Video Compression	H.265/H.264: Main/Baseline/High, MJPEG
Audio Compression	G.711 u-law /G.726 Selectable G.726(ADPCM) 8KHz, G.711 8KHz G.726: 16Kbps, 24Kbps, 32Kbps, 40Kbps AAC-LC: 48Kbps at 16KHz
Smart Codec	Manual(5ea area), WiseStream II
Bitrate Control	H.264/H.265: CBR or VBR MJPEG: VBR
Streaming	Unicast(20 users) / Multicast Multiple streaming(Up to 10 profiles)
Protocol	IPv4, IPv6, TCP/IP, UDP/IP, RTP(UDP), RTP(TCP), RTCP,RTSP, NTP, HTTP, HTTPS, SSL/TLS, DHCP, FTP, SMTP, ICMP, IGMP, SNMPv1/v2c/v3(MIB-2), ARP, DNS, DDNS, QoS, UPnP, Bonjour, LLDP, SRTP (TCP, UDP Unicast)
Security	HTTPS(SSL) Login Authentication Digest Login Authentication IP Address Filtering User access log 802.1X Authentication(EAP-TLS, EAP-LEAP) Device Certificate(Hanwha Techwin Root CA)
Application Programming Interface	ONVIF Profile S/G/T SUNAPI(HTTP API) Wisenet open platform
General	
Webpage Language	English, Korean, Chinese, French, Italian, Spanish, German, Japanese, Russian, Swedish,, Portuguese, Czech, Polish, Turkish, Dutch, Hungarian, Greek
Edge Storage	Micro SD/SDHC/SDXC 2 slots 1TB maximum capacity (512GBx2)
Memory	4096MB RAM, 512MB Flash
Environmental & Electrical	
Operating Temperature / Humidity	-40°C ~ +60°C (-40°F ~ +140°F) / Less than 95% RH
Storage Temperature / Humidity	-50°C ~ +60°C(-58°F ~ +140°F) / Less than 95% RH
Certification	IP66, IK10, NEMA4X, EN50155 class T3

Input Voltage	PoE(IEEE802.3af, Class 3) Mode A, 12VDC
Power Consumption	PoE: Maximum 12.95W, typical 11W 12VDC: Maximum 11W, typical 9.1W

Mechanical	
Color / Material	White / Aluminum, Hard-coated dome
RAL Code	RAL9003
Product dimensions / weight	Ø160x72mm(6.29x2.83"), 1100g(2.43lb)

DORI (EN62676-4 standard)	
Detect (25PPM/ 8PPF)	34.9m(114.49ft)
Observe (63PPM/ 19PPF)	13.9m(45.60ft)
Recognize (125PPM/ 38PPF)	7.0m(22.96ft)
Identify (250PPM/ 76PPF)	3.5m(11.48ft)

- The latest product information / specification can be found at hanwhasecurity.com
- Design and specifications are subject to change without notice.
- Wisenet is the proprietary brand of Hanwha Techwin, formerly known as Samsung Techwin.

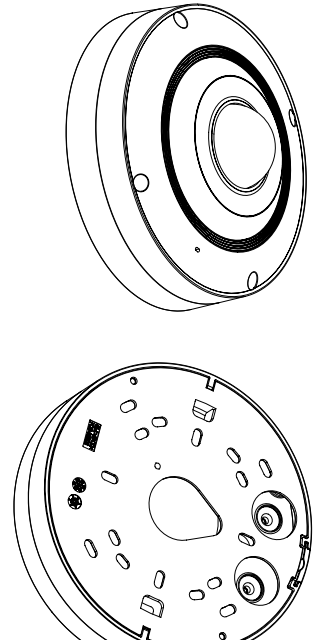
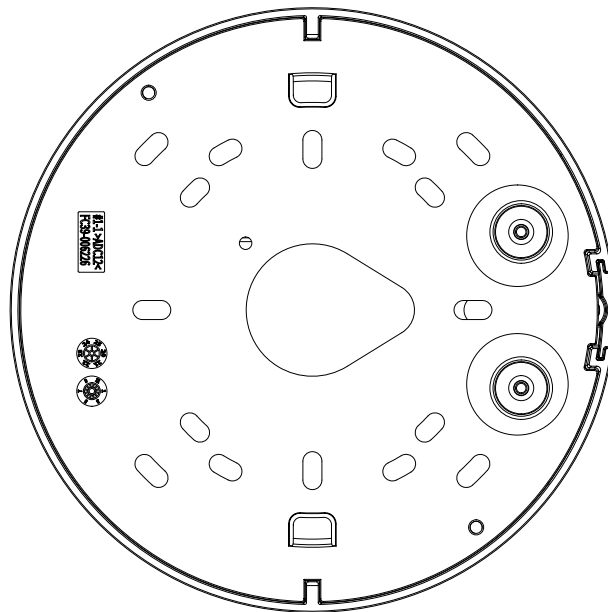
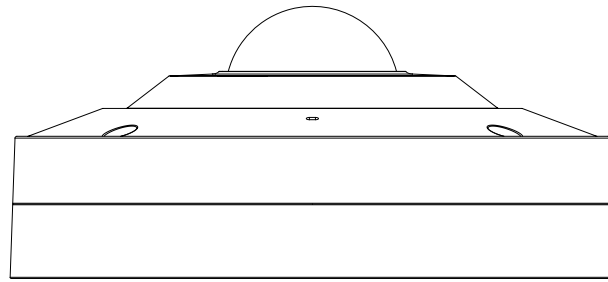
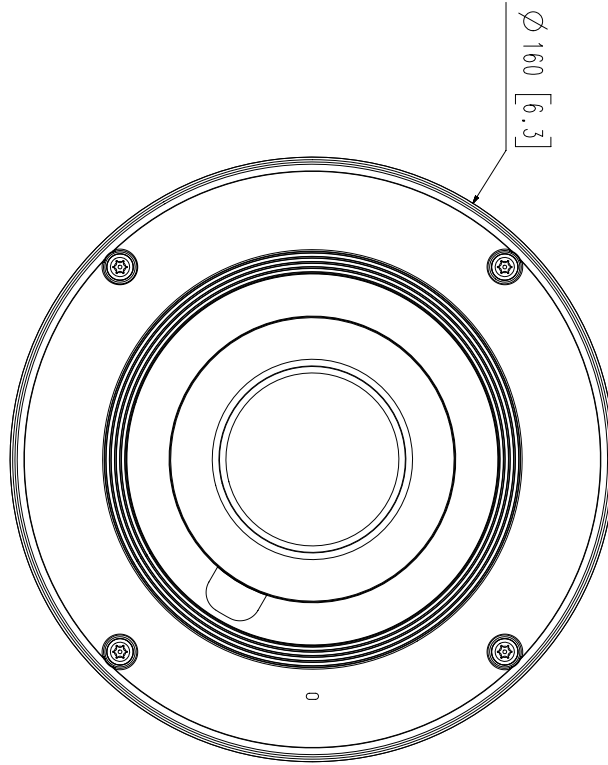
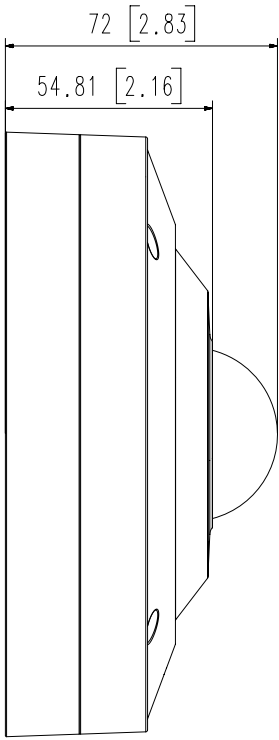

3	И-ЯМ MODEL2	
2	XNF-9010RVM	'20.09.21
1	XNF-9010RV	'20.09.21
No.	MODEL NAME	DATE
Unit : mm [inch]	SCALE : 1/1	