



COVERT CAMERA

COLOUR

PI-640/A



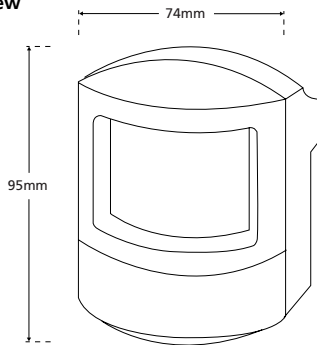

● 'Sharpshooter' PIR case colour camera

Front view

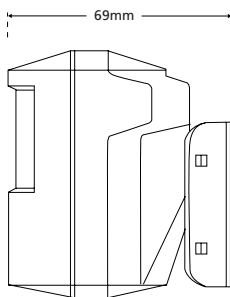

Side view



-  1/3" CCD
-  300 TV lines
-  5.0 lux sensitivity
-  Supply voltage: 12 Vdc
-  Audio output: 1V p-p

Lens options

Lens	Product Code
4.0mm	PI-640/A
2.5mm	PI-640/A/2.5
6.0mm	PI-640/A/6.0
8.0mm	PI-640/A/8.0
12.0mm	PI-640/A/12.0

All lens options are the same price

- Unique bracket for wall or corner mounting
- Ceiling mount bracket also available
- Standard rather than pinhole lens gives superior performance in low light conditions
- Scratch-resistant clear front for easy maintenance and optimal sensitivity
- Smoked window material also available for a more covert camera
- Comes with free power supply
- Comes with free audio capability
- Comes with lint-free cleaning cloth to remove grease and dirt from case and lens

See Also:

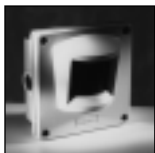

PI-610VR
Outdoor vandal-resistant colour PIR case camera

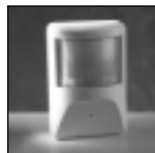

PI-380/PWA
Working PIR monochrome camera

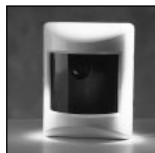

PI-350/A
PIR case monochrome camera

SPECIFICATION

Image sensor	MOD-630 camera module
Horizontal resolution	1/3" CCD sensor, 500 (H) x 582 (V) pixels
Lens options	300 TV lines or greater
Electronic shutter	SEE TABLE
Sensitivity	Automatic linear shutter
Video output	5.0 lux
Supply voltage	PAL, 1Vp-p, 75 Ohms
Working temperature	12 Vdc ± 10%
	-5°C to +40°C

VIDEO

AUDIO

Microphone	Omni-directional electret
Audio output	1Vp-p, 600 Ohms
Audio bandwidth	100Hz - 10KHz, +/- 3dB

Specification and availability of products are subject to change without notice