



VK-1316S/12V

Article-No.: 91931

1/3" B/W Camera, 570TVL, 12VDC

Mainfeatures

Resolution of 570 Horizontal Lines
Automatic Gain Control (AGC)
Aperture Control (APC)
Internal Synchronization
C/CS Mount

High Sensitivity
Automatic Shutter Control (AES)
Backlight Compensation (BLC)
Auto Iris and DC Iris Control
Supply Voltage: 12VDC



Specifications

System	black&white
Video standard	CCIR
Sensor size	1/3"
Imager	CCD
Imager	Sony Super HAD Interline Transfer
Active picture elements	440,000, (H) 752 x (V) 582
Horizontal resolution	570 TVL
Synchronization	Internal
Signal-to-noise ratio	46db (AGC OFF)
Gamma correction	0.45
Sensitivity (at 50% video signal)	0,1 Lux
Sensitivity (at 50% video signal)	at F1.2 (measured)
Automatic electronic shutter (ESC)	yes
Low Speed Shutter	no
Digital Noise Reduction (DNR)	no
Backlight compensation	BLC
Wide Dynamic Range (WDR)	no



Specifications (continued)

Aperture Correction (APC)	Horizontal and vertical
IR cut filter	no
Lens mount	CS
Iris control	Manual iris, Auto-Iris/DC controlled iris
Illumination	no
External adjustments	Shutter ON/OFF, AGC ON/OFF, AI/DC iris control, Flange focus Level for DC controlled lenses
Video outputs	Composite (CVBS)
Video outputs	1Vp-p, VBS, 75Ohm
External connections	Video (BNC), Auto Iris/DC iris (4 pin), Power input (2 pin)
Serial interfaces	no
Camera mount	1/4" - 20 UNC thread on top and bottom
Supply voltage	12VDC
Supply voltage	(+/-20%)
Power consumption	4watts
Housing	Indoor
Colour	Pantone 877, Front and back: Pantone 8400C
Hidden cable management	no
Protection rating	IP40
Temperature range (Operation)	-10° ~ +50°C
Dimensions (HxWxD)	See drawing
Weight	225g
Parts supplied	Camera, C/CS Mount ring, 4-pin lens plug, Manual
Certificates	CE

Optional Accessories

Image	Artikel-Nr. / Typ	Description
	VT-PS12DCDT1	PSU 12VDC/1.0A, Regulated, Desktop Version, 1.8m Cables each w. open ends
	WD-23	Wall Mount Bracket with Ball Joint, 1/4" Camera Fixing Screw, Pantone 877
	WD-22	Wall Mount Bracket with Ball Joint, 1/4" Camera Fixing Screw, Beige Grey

Optional Accessories (continued)

Image	Artikel-Nr. / Typ	Description
	WD-18	Wall Mount with Ball Joint, 1/4" Camera Fixing Screw, Beige Grey
	VT-PS12DC-7	Plugable PSU w. Cont. & UK Mains plug-in 100-240VAC/12VDC-1.25A, Regulated
	VT-PS12DC-9	Plug-in Power Supply Unit 100-240VAC 12VDC (1.0Amp), Regulated, w. open Ends

Technical Drawing

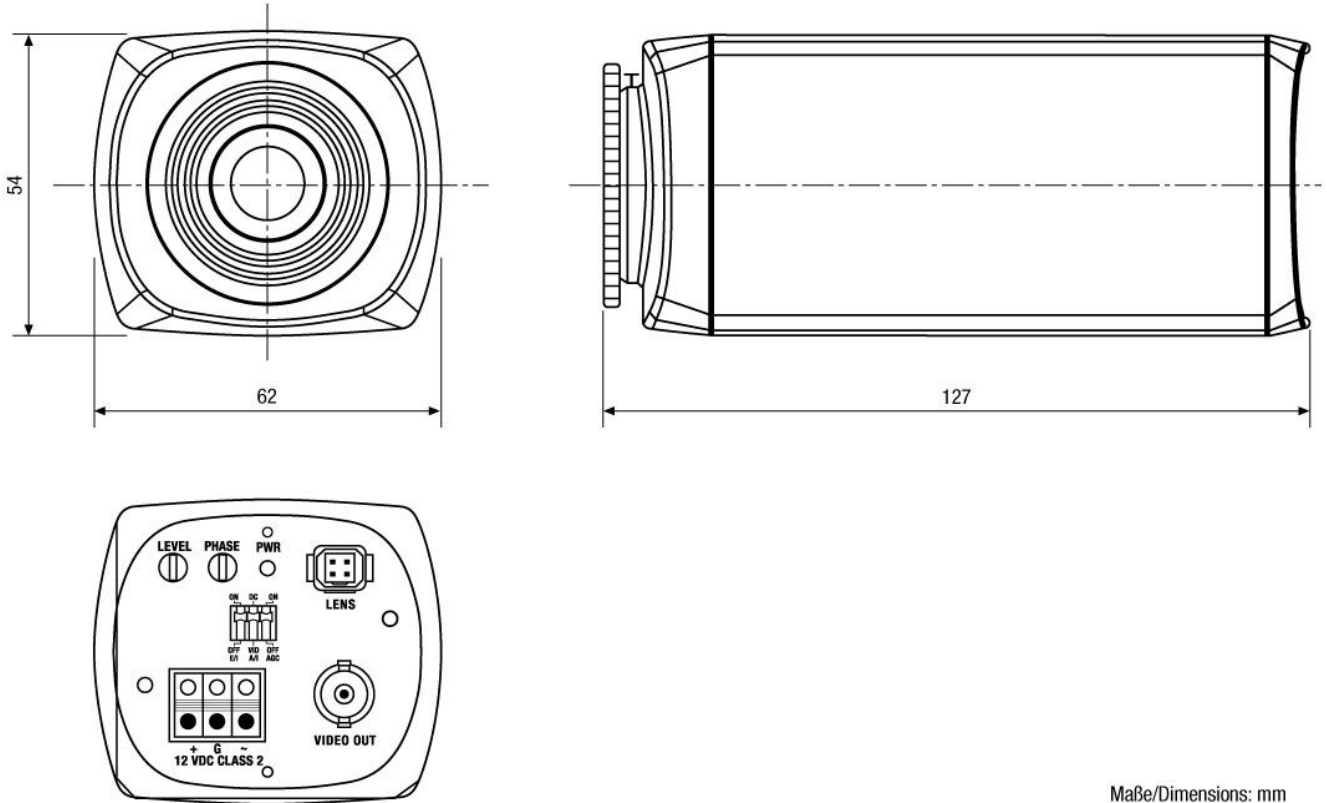

Maße/Dimensions: mm

Your partner for eneo products:

