

DC Controlled Lenses

FDP-No. : 43148

G0608NDDC

- Suitable for 1/2" and 1/3" Colour and B&W Cameras
- CS Mount
- High Standard of Optical and Mechanical Quality
- Aspherical Lens
- Without Built-in Auto Iris Amplifier
- With 4-pin Connector
- Adjustable Slip-ring Mount for Cable Positioning



Specifications:

Focal length (f)	6 mm
Aperture range (F)	F0.8-F360
Mount	CS
Nominal format size	1/2"
Flange focal length	12.5 mm
Horizontal angle of view at nominal format size	56.7°
Minimum object distance (M.O.D.)	0.25 m
Screw-in depth	B&W: 7.5 mm / Colour: 3.5 mm
Filter screw size	M40.5x0.5 mm
Cable length	Approx. 25 cm
Slip-ring mount	340°-360° Variable adjustment range
Iris control system	Galvanometer
4-pin plug	Standard
Temperature range	-20°C to +50°C
Dimensions (LxDxH)	43x46x33 mm
Weight	140 g

Accessories	
EDP No. / Type	Description
43094 ACB	Auto iris control box for DC iris lenses to AI output. With integrated Level and ALC adj. potentiom.

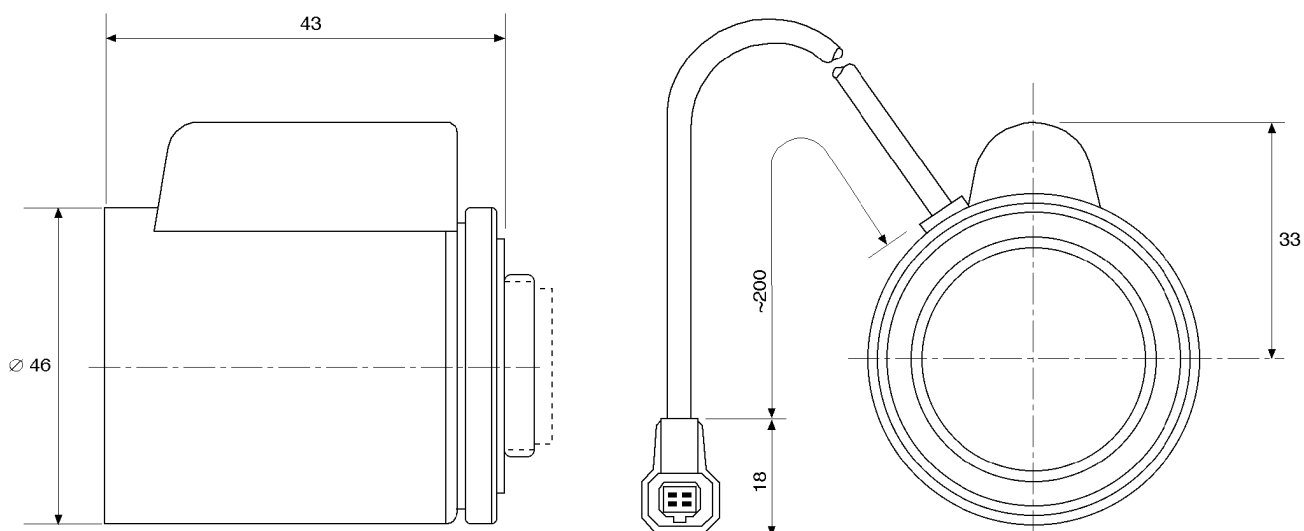

Maße/Dimensions: mm

e-mail: info@eneo-security.com • www.eneo-security.com