

DH-SD6AW130-HN

1.3Mp HD Network IR Wipe PTZ Dome Camera



Features

- Powerful 30x optical zoom
- H.264 & MJPEG dual-stream encoding
- Max 60fps@720P and 30fps@1.3M resolution
- WDR(120dB), Defog, Day/Night(ICR), Ultra DNR, Auto iris, Auto focus
- Support Wipe
- Multiple network monitoring: Web viewer, CMS(DSS/PSS) & DMSS
- Max 240°/s pan speed, 360° endless pan rotation
- Up to 255 presets, 5 auto scan, 8 tour, 5 pattern
- Built-in 7/2 alarm in/out
- Support intelligent 3D positioning with DH-SD protocol
- Micro SD memory, IP66
- IR Distance up to 150m

DH-SD6AW130-HN

Technical Specifications

Model	DH-SD6AW130-HN
Camera	
Image Sensor	1/3" Exmor CMOS
Effective Pixels	1280(H) x 960(V)
Scanning System	Progressive
Electronic Shutter Speed	1/1 ~ 1/30,000s
Min. Illumination	Color: 0.05Lux@F1.6; B/W: 0.005Lux@F1.6
S/N Ratio	More than 50dB
Video Output	BNC(1.0Vp-p/75Ω), PAL / NTSC
Camera Features	
Day/Night	Auto(ICR) / Color / B/W
Backlight Compensation	BLC / HLC / WDR (120db)
White Balance	Auto, ATW, Indoor, Outdoor, Manual
Gain Control	Auto / Manual
Noise Reduction	Ultra DNR (2D/3D)
Privacy Masking	Up to 24 areas
Digital Zoom	16x
Defog	On / Off
Wipe	Support
Lens	
Focal Length	4.3mm ~129mm(30x Optical zoom)
Max Aperture	F1.6 ~ F5.0
Focus Control	Auto / Manual
Angle of View	H: 65.1°~ 2.34°
Close Focus Distance	10mm~ 1200mm
PTZ	
Pan/Tilt Range	Pan: 0° ~ 360° endless; Tilt: -10° ~ 90°, auto flip 180°
Manual Control Speed	Pan: 0.1° ~200° /s; Tilt: 0.1° ~120° /s
Preset Speed	Pan: 240° /s; Tilt: 200° /s
Preset	80(DH-SD), 255(Pelco-P/D)
PTZ Mode	5 Pattern, 8 Tour, Auto Pan, Auto Scan
Speed Setup	Human-oriented focal length/ speed adaptation
Power up Action	Auto restore to previous PTZ and lens status after power failure
Idle Motion	Activate Preset/ Pan/ Scan/ Tour/ Pattern if there is no command in the specified period
Time Task	Auto activation of Preset/ Pan/ Scan/ Tour/ Pattern by preset-time
Protocol	DH-SD, Pelco-P/D (Auto recognition)
IR Distance	150m (2 near IR LED+ 8 far IR LED)
Video	

DH-SD6AW130-HN

Compression		H.264 / MJPEG
Resolution		1.3M(1280×960) / 720P(1280×720) / D1(704×576/ 704×480) /CIF (352×288/352×240)
Frame Rate	Main Stream	1.3M(1~25/30fps),720P (1~50/60fps)
	Sub Stream	D1/CIF(1 ~ 25/30fps)
Bit Rate		H.264: 56K ~ 8192Kbps, MJPEG: 56K ~ 20480Kbps
Audio		
Compression		G.711a / G.711u(32kbps)/ PCM(128kbps)
Interface		1/1 channel In/Out
Network		
Ethernet		RJ-45 (10/100Base-T)
Protocol		IPv4/ IPv6, HTTP, HTTPS, SSL, TCP/IP, UDP, UPnP, ICMP, IGMP, SNMP, RTSP, RTP, SMTP, NTP, DHCP, DNS, PPPOE, DDNS, FTP, IP Filter, QoS, Bonjour, 802.1x
ONVIF		ONVIF Profile S
Max. User Access		20 users
Smart Phone		iPhone, iPad, Android, Windows Phone
Auxiliary Interface		
Memory Slot		Micro SD, Max 64GB
RS485		1
Alarm		7/2 channel In/Out
General		
Power Supply		AC 24V/3A (±16%)
Power Consumption		20W, 43W (IR on, Heater on)
Working Environment		-40°C ~ 70°C / Less than 90% RH
Ingress Protection		IP66
Dimensions		Φ252(mm) x 385 (mm)
Weight		6.75kg

DH-SD6AW130-HN

Dimensions (mm)

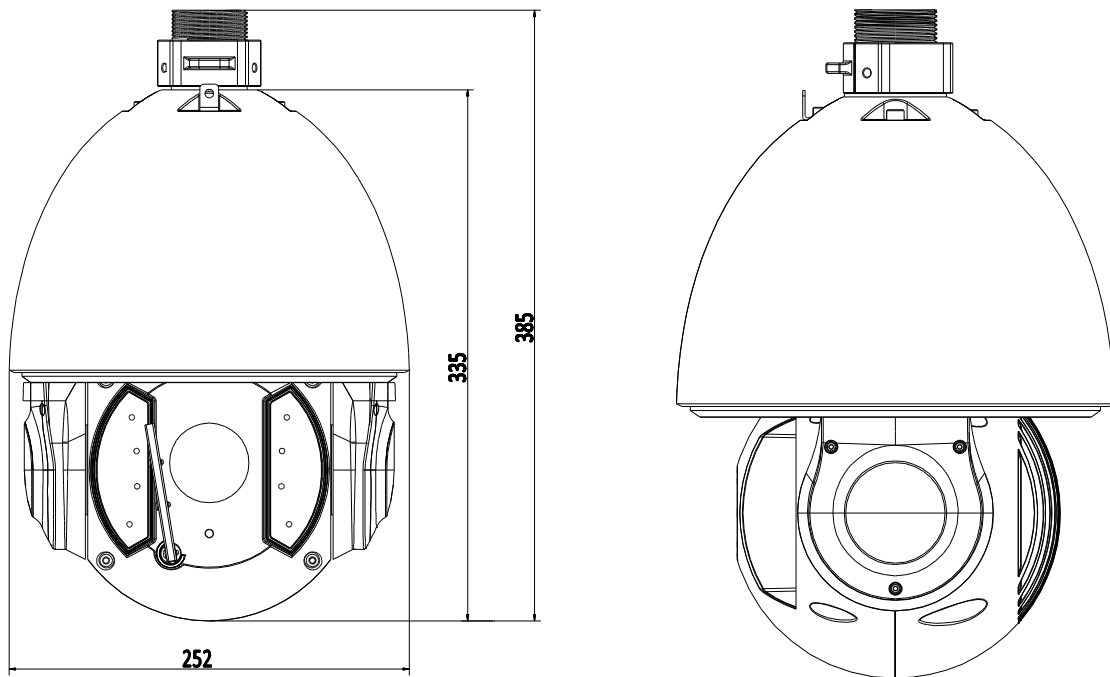







Accessories

		
DH-69FB	DH-PFA111	Power Supply

DH-SD6AW130-HN

Accessories (Optional)

			
DH-PFB300C	DH- PFB301C	DH-PFA112	DH-PFA113
			
DH- PFA120	DH-PFA150	DH-PFA151	

Dahua Technology Co., Ltd.

1199 BinAn Road, Binjiang District, Hangzhou, China

Tel: +86-571-87688883

Fax: +86-571-87688815

Email: overseas@dahuatech.com

www.dahuasecurity.com

*Design and specifications are subject to change without notice.

© 2014 Dahua Technology