

DH-SD6923/6930/6936/6970-H

23x/30x/36x IR PTZ Dome Camera



Features

- Powerful 23x/30x/36x optical zoom
- High resolution@700TVL/600TVL
- DWDR, Day/Night (ICR), DNR (2D&3D), Auto iris, Auto focus, AWB, AGC, BLC
- Max 240°/s pan speed, 360° continuous pan rotation
- Up to 255 presets, 5 auto scan, 8 tour, 5 pattern
- Built-in 7/2 alarm in/out
- Support intelligent 3D positioning with DH-SD protocol
- IP66, IR LEDs up to 100m

DH-SD6923/6930/6936/6970-H

Dimensions (mm)

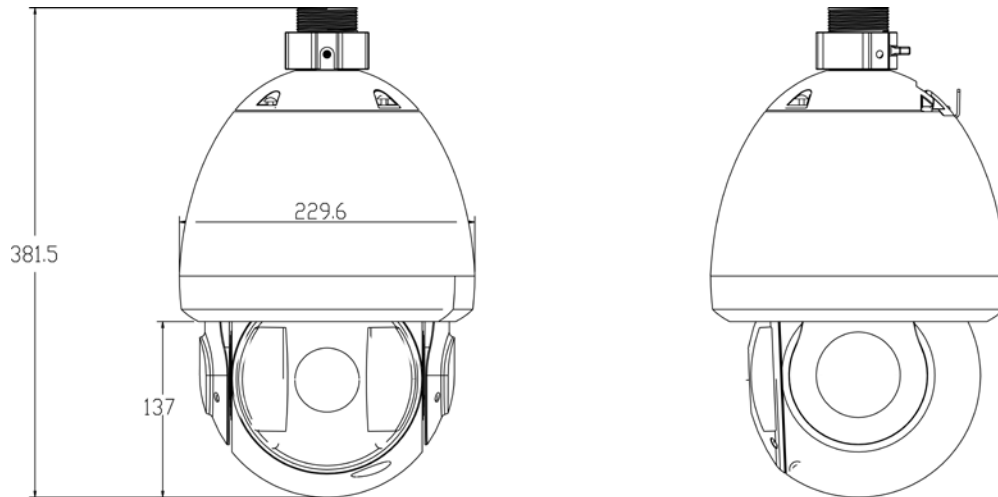

DH-SD6923/6930/6936/6970-H

Technical Specifications:

Model	DH-SD6923-H	DH-SD6930-H	DH-SD6936-H	DH-SD6970-H
Camera				
Image Sensor	1/4" Super HAD CCD II		1/3" EXview HAD CCD II	
Effective Pixels	752(H) × 582(V) / 768 (H) × 494(V)		976(H) × 582(V) / 976(H) × 494(V)	
Horizontal Resolution	Color: 600TVL; B/W: 650TVL		Color: 700TVL B/W: 750TVL	
Scanning System	Interlacing			
Electronic Shutter Speed	1/1s ~ 1/100,000s			
Min. Illumination	Color: 0.01 Lux/F1.6 B/W: 0.001Lux/F1.6		Color: 0.001Lux/F1.6 B/W: 0.0001Lux/F1.6	
S/N Ratio	More than 50dB			
Video Output	BNC(1.0Vp-p/75Ω), PAL / NTSC			
Camera Features				
Max. IR LEDs Length	100m			
Day/Night	Auto(ICR) / Color / B/W			
Backlight Compensation	BLC / HLC / DWDR (Digital WDR)			
White Balance	Auto, ATW, Indoor, Outdoor, Manual			
Gain Control	Auto / Manual			
Noise Reduction	2D / 3D			
Privacy Masking	Up to 24 areas			
Digital Zoom	16x			
Lens				
Focal Length	3.9mm~89.7mm (23x Optical zoom)	3.4mm~102mm (30x Optical zoom)	3.4mm~122.4mm (36x Optical zoom)	3.9mm ~ 89.7mm (23x Optical zoom)
Max Aperture	F1.6~ F3.7	F1.6~F4.5	F1.6~ F4.5	F1.6~ F2.7
Focus Control	Auto / Manual			
Angle of View	H: 61.68° ~ 3.06°	H: 57.58°~2.3°	H: 57.8°~1.7°	H: 57.58°~ 3.12°
Close Focus Distance	10mm~1000mm			
PTZ				
Pan/Tilt Range	Pan: 0° ~ 360° endless; Tilt: -2° ~ 90°, auto flip 180°			
Manual Control Speed	Pan: 0.1° ~ 160°/s; Tilt: 0.1° ~ 120°/s			
Preset Speed	Pan: 240°/s; Tilt: 200°/s			
Preset	80(DH-SD) , 255(Pelco-P/D)			
PTZ Mode	5 Pattern, 8 Tour, Auto Pan, Auto Scan			
Speed Setup	Human-oriented focal length/ speed adaptation			

DH-SD6923/6930/6936/6970-H

Power up Action	Auto restore to previous PTZ and lens status after power failure
Idle Motion	Activate Preset/Pan/Scan/Tour/Pattern if there is no command in the specified period
Time Task	Auto activation of Preset/Pan/Scan/Tour/Pattern by preset-time
Protocol	DH-SD, Pelco-P/D (Auto recognition)
Auxiliary Interface	
RS485	1 port
Alarm	7/2 channel In/Out
General	
Power Supply	AC24V/3A ($\pm 10\%$), DC12V optional
Power Consumption	17W, 35W (IR on)
Working Environment	-40°C ~ 60°C / Less than 90% RH
Ingress Protection	IP66
Dimensions	$\Phi 229.6(\text{mm}) \times 381.5(\text{mm})$
Weight	7.0kg

Dahua Technology Co., Ltd.

1187 BinAn Road, Binjiang District, Hangzhou, China

Tel: +86-571-87688883

Fax: +86-571-87688815

Email: overseas@dahuatech.com

www.dahuatech.com

*Design and specifications are subject to change without notice.

© 2012 Dahua Technology Co., Ltd.