

H0614FICS-3

6.0mm F1.4

for 1/2" format cameras

CS-Mount

Model No.	H0614FICS-3		Effective	Front	φ 10.8 mm
Focal Length	6.0 mm		Lens Aperture	Rear	φ 8.6 mm
Max. Aperture Ratio	1 : 1.4		Back Focal Length	8.2 mm	
Max. Image Format	6.4 X 4.8 mm (φ 8 mm)		Flange Back Length	12.5 mm	
Operation	Iris	F1.4 ~ 16C	Mount	CS-Mount	
	Focus	0.2m ~ Inf.	Filter Size	M30.5 x 0.5	
Object Dimension at M.O.D.	22.3 x 16.3 cm		Dimensions	φ 34.5 x 33.0 mm	
			Weight	35 g	
Angle of View	D	71.3°			
	H	58.3°			
	V	44.3°			

1/2

M.O.D. : Minimum Object Distance

Dimensions

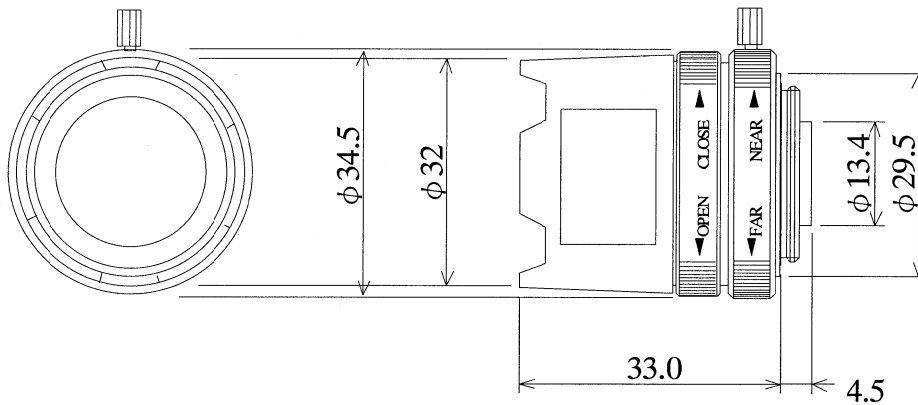

CS

F