

2.0 Megapixel WDR HD Bullet Camera



Avigilon's end-to-end surveillance solutions deliver image detail no other system can match. Avigilon Control Center software, featuring High-Definition Stream Management™ (HDSM™) technology combined with our broad range of megapixel cameras (from 1 MP to 29 MP) provide unprecedented clarity—while effectively managing storage and bandwidth requirements. Our components are scalable and can work together in an end-to-end system, or can be customized to create your own powerful and cost-effective solution.

The innovative HD Bullet camera is just one way Avigilon can help provide the very best monitoring and protection.

H.264 HD CAMERA



Avigilon's 2.0MP HD Bullet camera is ideal for seeing objects and activity in complete darkness. With our unique adaptive IR technology, this camera is equipped to provide both wide and narrow illumination, enabling consistent illumination in complete darkness to maximize image quality regardless of scene conditions. Avigilon's 2.0MP HD Bullet camera also feature wide dynamic range (WDR) capabilities and is vandal resistant for maximum security. The Bullet camera is ideal for monitoring a variety of environments that require discreet nighttime coverage, including parking lots, campuses and industrial yards.

KEY FEATURES

2.0 megapixel progressive scan CMOS sensor
Unsurpassed image quality in daytime and nighttime
Available with 3-9 mm F1.2 or 9-22 mm F1.6 P-Iris lens with remote focus and zoom
30 images per second at full resolution
100 dB true dynamic range
Integrated IR (Infrared) LEDs provide uniform illumination in the dark, even at 0 lux, up to maximum of 200 ft (60 m) away
Zoom adaptive IR provides the most effective illumination at all zoom positions
Content adaptive IR prevents image saturation while maintaining optimum scene illumination
Automatic Day/Night functionality with removable IR cut filter to switch to Day or Night mode depending on the light level
PoE (Power over Ethernet) enables operating temperatures of -40°C to 50°C (-40°F to 122°F) with no auxiliary power required.
Additional configuration Ethernet port for easy installation
ONVIF compliant API with H.264 and Motion JPEG compression
Vandal resistant construction and IP66 compliant

Specifications

Outline Dimensions

	2.0W-H3-BO1-IR	2.0W-H3-BO2-IR		
CAMERA	Image Sensor	WDR 1/3" progressive scan CMOS		
	Active Pixels	1920 (H) x 1080 (V)		
	Imaging Area	4.2 mm (H) x 2.4 mm (V); 0.165" (H) x 0.094" (V)		
	Illuminator Technology	High-power IR LEDs		
	Maximum IR Illumination Distance at 0 lux	30 m (100 ft)	60 m (200 ft)	
	Wavelength	850 nm		
	Minimum Illumination	0.2 lux (F1.2) in color mode; 0 lux in monochrome mode with IR	0.4 lux (F1.6) in color mode; 0 lux in monochrome mode with IR	
	Dynamic Range	100 dB		
	Lens	3-9 mm, F1.2, P-Iris, remote focus and zoom	9-22 mm, F1.6, P-iris, remote focus and zoom	
	Angle of View	26° - 79°	11° - 26°	
	Image Compression Method	H.264 (MPEG-4 Part 10/AVC), Motion JPEG		
	Image Rate	30 (all resolutions)		
	Motion Detection	Selectable sensitivity and threshold		
	Electronic Shutter Control	Automatic, Manual (1/6 to 1/8000 sec)		
	Iris Control	Automatic, Manual		
	Day/Night Control	Automatic, Manual		
	Flicker Control	50 Hz, 60 Hz		
	White Balance	Automatic, Manual		
	Backlight Compensation	Automatic		
	Privacy Zones	Up to 4 zones		
Audio Compression Method	G.711 PCM 8 khz			
Audio Input/Output	Line level input and output			
External I/O Terminals	Alarm In, Alarm Out			
NETWORK	Network	100BASE-TX		
	Cabling Type	CAT5		
	Connector	RJ-45		
	API	ONVIF compliant (www.onvif.org)		
	Security	Password protection, HTTPS encryption, digest authentication, WS authentication, user access log.		
	Protocol	IPv4, HTTP, HTTPS, SOAP, DNS, NTP, RTSP, RTCP, RTP, TCP,UDP, IGMP, ICMP, DHCP, Zeroconf, ARP		
	Streaming Protocols	RTP/UDP, RTP/UDP multicast, RTP/RTSP/TCP, RTP/RTSP/HTTP/TCP, RTP/RTSP/HTTPS/TCP, HTTP		
	MECHANICAL	Dimensions (LxWxH)	241.7 mm x 94.9 mm x 70 mm (9.5" x 3.7" x 2.8")	
Weight		1.15 kg (2.5 lbs)		
Body		Aluminum		
Housing		Surface mount, tamper resistant		
Finish		Powder coat, cool gray 2		
Adjustment Range		±175° pan, -45° to +90° tilt, ±175° azimuth		
ELECTRICAL	Power Consumption	22 W with external power 12.95 W with IEEE 802.3af Class 3 PoE		
	Power Source	VDC: 12 V +/- 10%, 22 W min VAC: 24 V +/- 10%, 28 VA min PoE: IEEE802.3af Class 3 compliant		
ENVIRONMENTAL	Operating Temperature	-40°C to +50°C (-40°F to 122°F)		
	Storage Temperature	-10°C to +70°C (14°F to 158°F)		
	Humidity	20 - 80% Relative humidity (non-condensing)		
CERTIFICATIONS	Safety	UL 60950 CSA 60950 CB Scheme	UVV CE ROHS	WEEE C-Tick
	Environmental	IK10 Impact Rating		Meets IP66 Weather Rating
	Electromagnetic Emissions	FCC Part 15 Subpart B Class B	IC ICES-003 Class B	EN 55022 Class B
	Electromagnetic Immunity	EN 55024 Class B EN 61000-4-2 EN 61000-4-3	EN 61000-4-4 EN 61000-4-5	EN 61000-4-6 EN 61000-4-11
ORDERING INFORMATION	2.0W-H3-BO1-IR	2.0 Megapixel WDR 3-9mm HD Bullet Camera		
	2.0W-H3-BO2-IR	2.0 Megapixel WDR 9-22mm HD Bullet Camera		

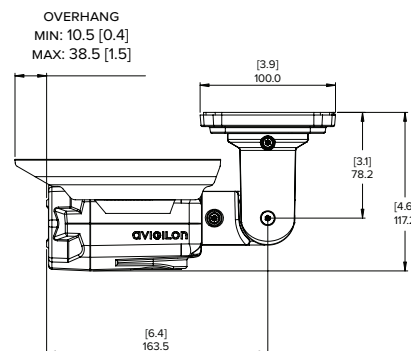
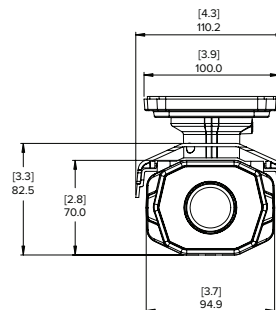

[X.X]	INCHES
X	MM

2.0W-H3-BO1-IR
2.0W-H3-BO2-IR