

COMPARISON BETWEEN GT SYSTEM AND GH SYSTEM

	GT system	GH system
Total Residential stations	Standard:48 stations (picture memory type: 48 masters and 144 subs) Expanded: 500 stations (picture memory type: 500 masters and 1500 subs)	Standard:48 stations Expanded: 500 stations
Number of Residential Stations within a Residence	Up to 4 stations (up to 2 monitors) (picture memory type: up to 4 monitors)	Up to 4 stations (up to 2 monitors)
Zoom & Pan tilt	Available	Not available
Picture memory	Available (picture memory station only)	Not available
Camera angle preset	Available	Not available
Audio guidance on entrance station	Available (GT-DM and GT-DA-L only)	Not available
Video door station at residence	Available (picture memory station only)	Not available
Call tone selection	Available (picture memory station only)	Not available
Switches between entrance station and CCTV camera	Available	Not available
Security sensor connection	Available (picture memory station only)	Not available
Number of access codes on entrance station	Up to 500	Up to 20
Code length of access code on entrance station	4, 5, or 6 digits	4 digits
T-coils for hearing aid	Available	Not available
PC connection at programming	USB	RS232C

*GT series cannot be combined with GF or GH Series.

UNIT DIMENSIONS

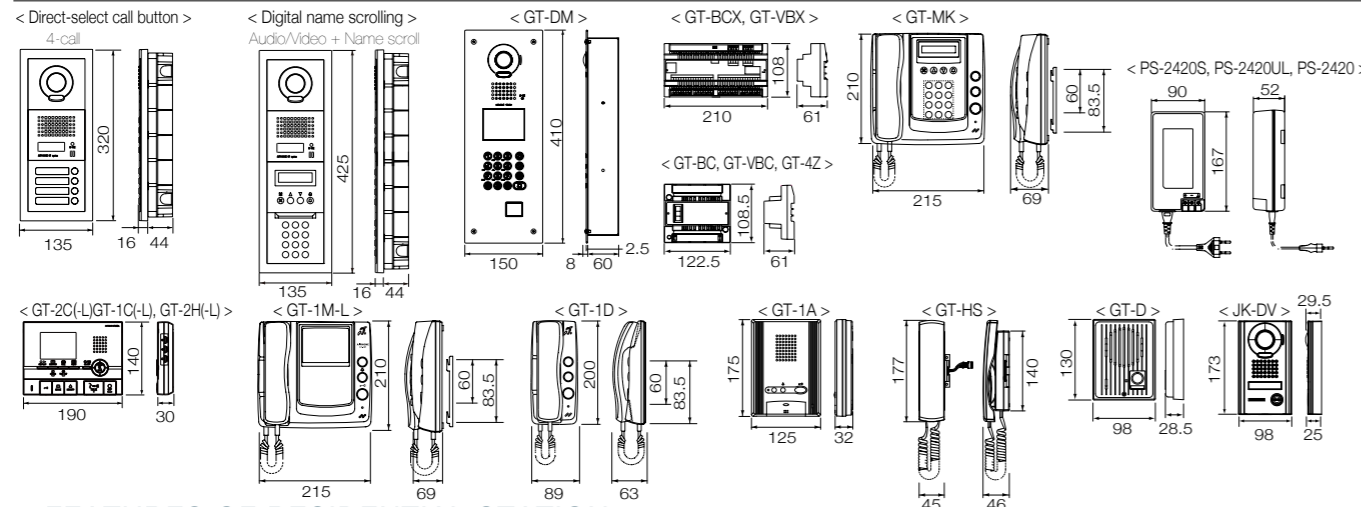

FEATURES OF RESIDENTIAL STATION

Model name	Description	Picture memory	Zoom & Pantilt	T-coils mode	Communication	GT-HS	Service button	Residential door station	Residential door bell	Security sensor
GT-2C	Video apartment master station	✓	✓	-	Hands-free	✓	✓	✓	✓	✓
GT-2C-L	Video apartment master station	✓	✓	✓	Hands-free	✓	✓	✓	✓	✓
GT-1C	Video apartment station	-	✓	-	Hands-free	✓	✓	-	✓	-
GT-1C-L	Video apartment station	-	✓	✓	Hands-free	✓	✓	-	✓	-
GT-2H	Video apartment sub master station	-	✓	-	Hands-free	✓	✓	✓*	✓*	✓*
GT-2H-L	Video apartment sub master station	-	✓	✓	Hands-free	✓	✓	✓*	✓*	✓*
GT-1M-L	Video apartment station	-	-	✓	Handset	-	✓	-	✓	-
GT-1A	Audio apartment station	-	-	-	Hands-free	-	✓	-	✓	-
GT-1D	Audio apartment station	-	-	✓	Handset	-	✓	-	✓	-

* Function of GT-2C and GT-2C-L

CAMERA POSITION & IMAGE VIEW AREA

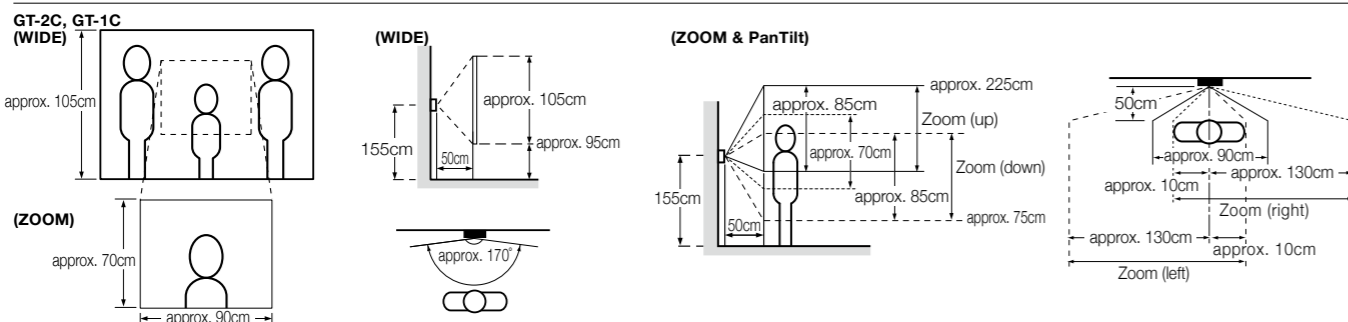

The image on the monitor is simulated to explain the functions. It is different from the actual image.

Distributed by :



AIPHONE®
Providing Peace of Mind

<http://www.aiphone.net/>
Printed in Japan
QB53025A0Z

GT(E)1103A

All rights reserved. All statements valid at time of printing. The design and specifications are subject to change without notice for improvement.



GT SERIES

Hands-Free Color Video Apartment system with Recording, Zoom & PanTilt features





For Apartment Buildings

Sophisticated Design and Reliable Security

The GT Series provides an innovative wide angle camera view to provide better security to residents.

Residents can record their visitors anytime they want, even during their absence. This recording function gives them greater peace of mind.

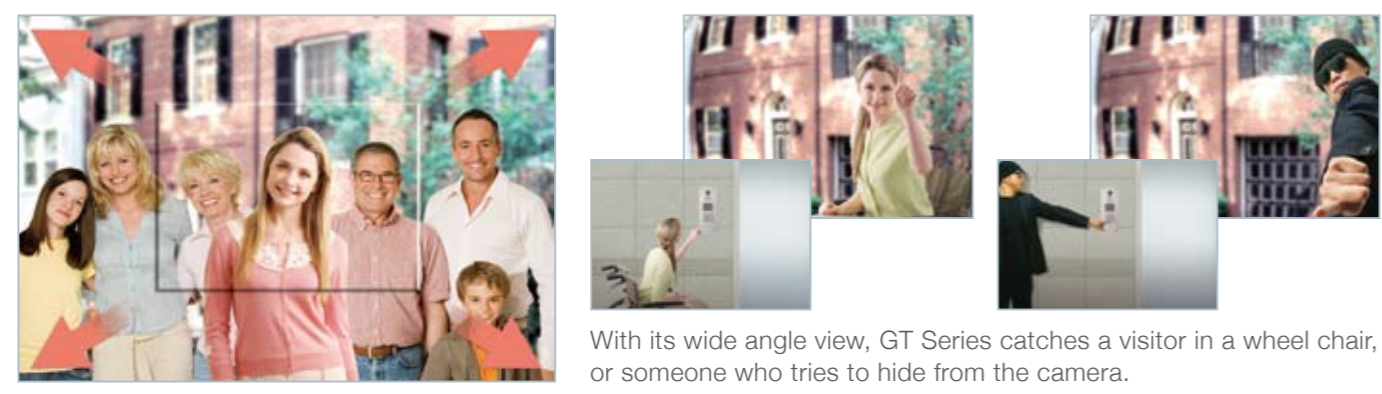

With its wide angle view, GT Series catches a visitor in a wheel chair, or someone who tries to hide from the camera.



Records 6 shots per picture sequence.

If a call is received from the Entrance Station, the Residential Station automatically starts recording, or residents start recording anytime by pressing the REC button manually.

Residential Station



Supports Hearing Aid with T-mode **GT-2C-L, GT-1C-L, GT-1M-L**

A T-coil mode is now available with the GT Series. If your hearing aid features T-mode, the sound from the GT Residential Station is much clearer than other intercoms.

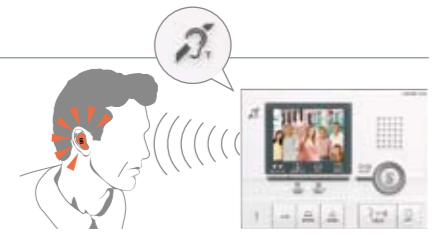

Picture Memory **GT-2C-L, GT-2C**

Automatic Recording

Works anytime, even during your absence. Records 6 images per picture sequence. Up to 40 pictures sequences can be recorded.

Manual Recording

Record picture as required. The recording starts when you press the REC button while monitoring or talking to a visitor.

Playing

The play LED flashes when there are auto-recorded pictures. Press the PLAY button to play.



Additional Security **GT-2C-L, GT-2C**

The Master Station with the recording function can be connected with 3 security lines and an emergency button. If a connected sensor detects a break-in, or an emergency button is pressed, the alarm will be triggered after the set time. (An emergency button can be connected to any Master Station.)

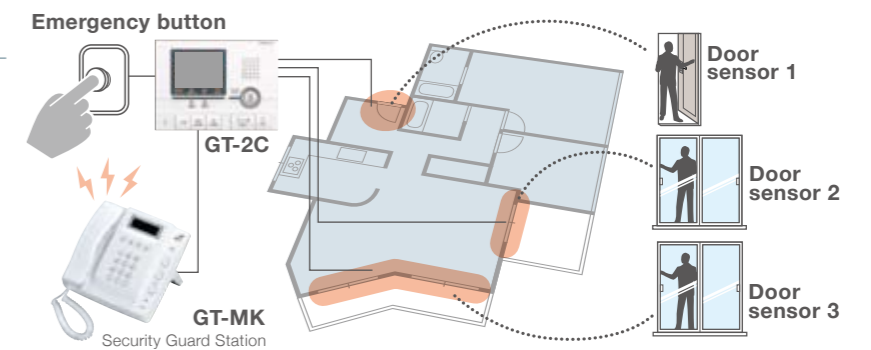

Wide and Zoom & PanTilt **GT-2C-L, GT-2C, GT-1C-L, GT-1C**

Panoramic Wide Angle View

To provide effective security, GT Series features a wide angle camera that enables you to see an innovative panoramic view! People standing on sides and people of all heights can be easily identified.

Zoom

To see details, switch to Zoom mode. Switching between Wide and Zoom mode can be done by the press of a button.

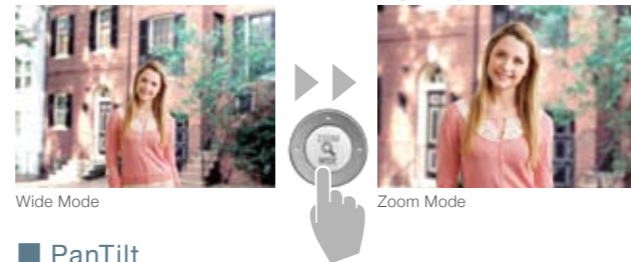

PanTilt

PAN/TILT is available to change the camera angle in Zoom mode.

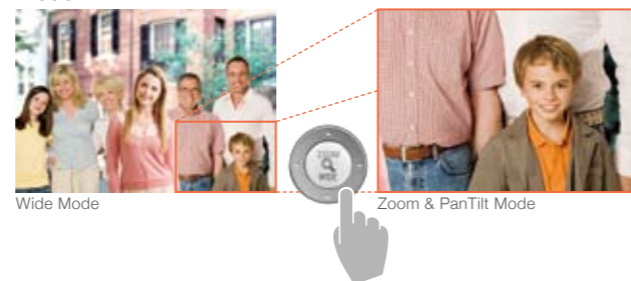

Find a Matching Style



Residential Station in 5 styles to select.

Up to 4 Residential Stations can be installed per residence. Room to room communication is available between them.



Door Station

You can now identify visitors not only at the apartment entrance, but also at your door. The Door Station sends a clear color image just like the Entrance Station.



Main Features of the Camera

- Fish Eye wide lens camera
- Automatic LED illuminator for low light conditions
- Both with/without camera types are available.

Entrance Station



Audio & Visual Guidance

The Entrance Station features both audio and visual guidance, so any visitor knows the present situation. The audio guide is available in 6 languages (English, French, German, Spanish, Dutch, and Italian).

There are projections on the buttons to help visually impaired visitors.



2 Styles to Choose From

Select from the All-in-one type or Module type. The All-in-one comes with the large display, digital name scrolling feature, and sophisticated design. The Module has a direct-select call feature, and can be flexibly combined with the direct button panels.



Optional Security Camera for More Security

To eliminate blind spot and ensure entrance security, you can add the optional security camera.

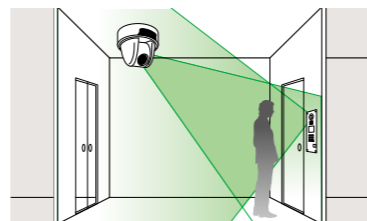

Panoramic View Angle & Clear Color Image

With the white LED illuminator, the camera sends color images to Residential Station monitors at any time. Clear color image is always available! With its advanced camera, you can identify visitors and monitor the entrance.



Convenient Resident Search

With the Digital Name Scrolling station, visitors can find the residents easily by their names or room number using the digital keypad. Directory search is also available.

* With alpha and numeric characters, room numbers can be entered (max. 6 characters).
Scandinavian added for showing resident names (max. 16 characters).



Other Features

- Up To 500 Four-Digit Access Codes Can Be Set.
- Both with/without camera types are available.

Security Guard Station



Reception Mode

Using this function, all Entrance Station calls are automatically transferred to the Security Guard Station, giving the Security guard the ability to screen visitors.



Missed Calls Recording

Records up to 20 missed calls made from Residential Stations. To call back, display the resident's name and room number recorded, and then press the Call button. It's quick and easy.



Other Features

- Receives panic call from Residential Stations.
- Optional doorbell at security/reception room is available.
- Supports Hearing Aid with T-mode.
- Both wall and desk-top installations are available.



GT-MK



GT-MK with desk-top stand

Installer-Friendly Terminal Block

The terminal block can be removed from the station unit. It makes the installation easier and protects the station against theft during the installation.



Installation Advantage

Installation and Setup is Quick and Easy

- Employs 1 pair for audio & 1 pair for video connections
- Easy link to Residential Station from Entrance and Security Guard Stations
- Programmed data can be transferred to other GT-DM, GT-NS and GT-MK's
- For GT-DM, GT-NS and GT-MK, system setup data is programmable on your PC. GT-DM, and GT-NS, GT-MK & PC can be connected with a USB connection cable. Setup tool software is supported in 6 different languages (English, French, German, Spanish, Italian and Dutch). The system setting tool is compliant with Windows XP, Windows VISTA and Windows 7.

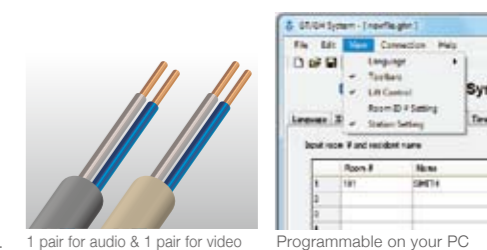

1 pair for audio & 1 pair for video

Programmable on your PC

Expanded System Advantage

Operates Up to 16 Entrance Stations, 4 Security Guard Stations, and 500 Residential Stations: Ideal for Large Apartment Complexes!

The GT series can accommodate large complexes with underground parking, complex building layouts, and many residents. It provides two Communication (talk and video) paths*, one per Common-Sub trunk. Choose the installation configuration that best suits your application. The design flexibility and capacity of the GT makes it suitable for all multi-unit applications, large and small.

* Communication paths are subject to installation requirements. See page 8 for more details.

Two communication paths available

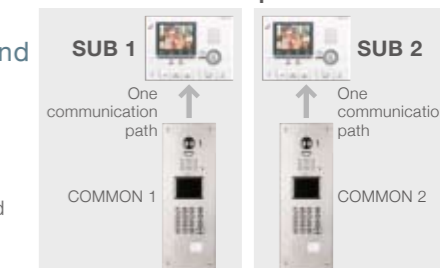

System Configuration

Standard system

5 Entrance stations
2 Security guard stations
48 Residential stations

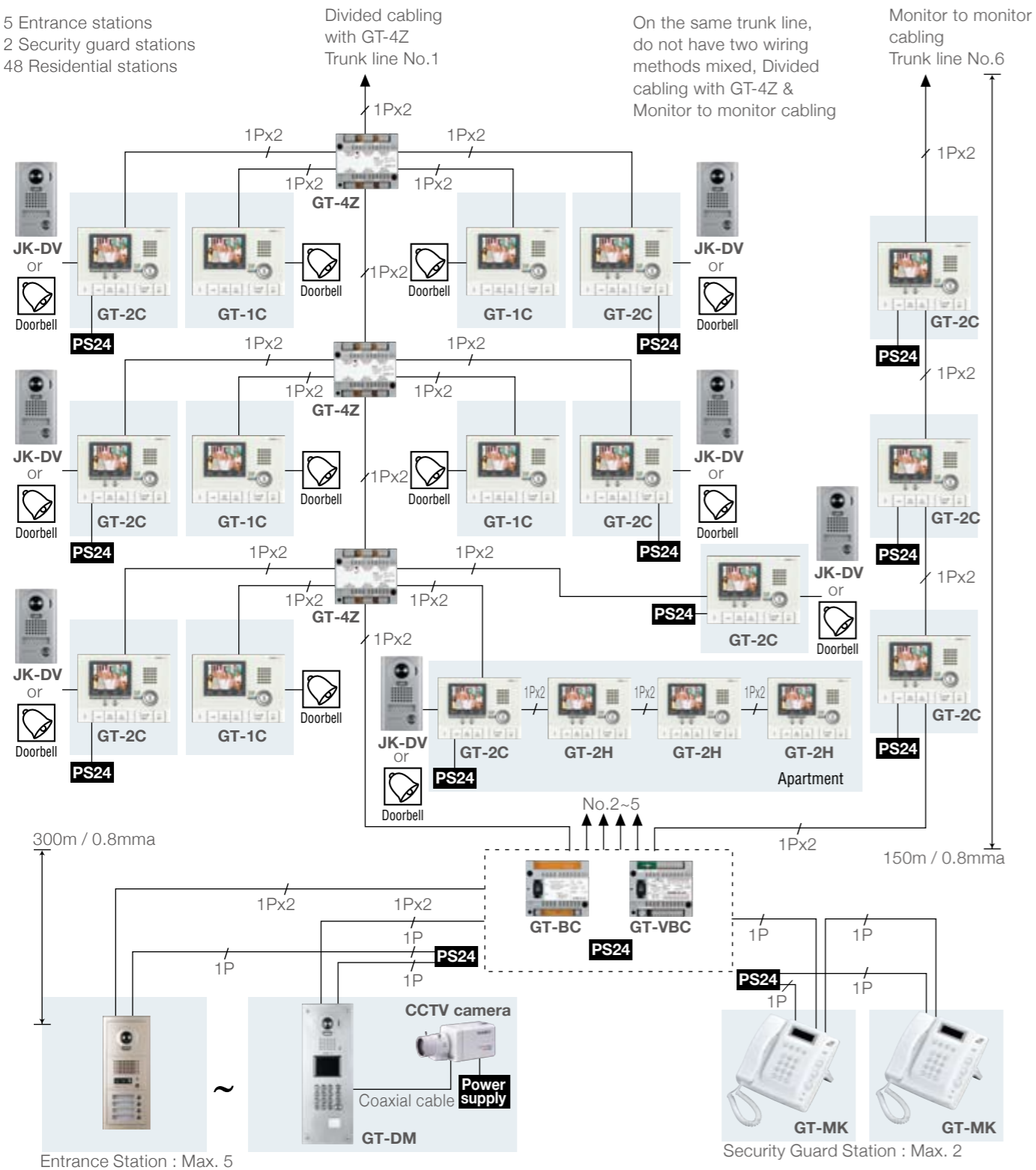

Expanded system

16 Entrance stations, 2 common trunk lines (8 each per common line)
4 Security guard stations, 2 common trunk lines (2 each per common line)
500 Residential stations, 4 sub trunk lines (125 each per sub trunk line)

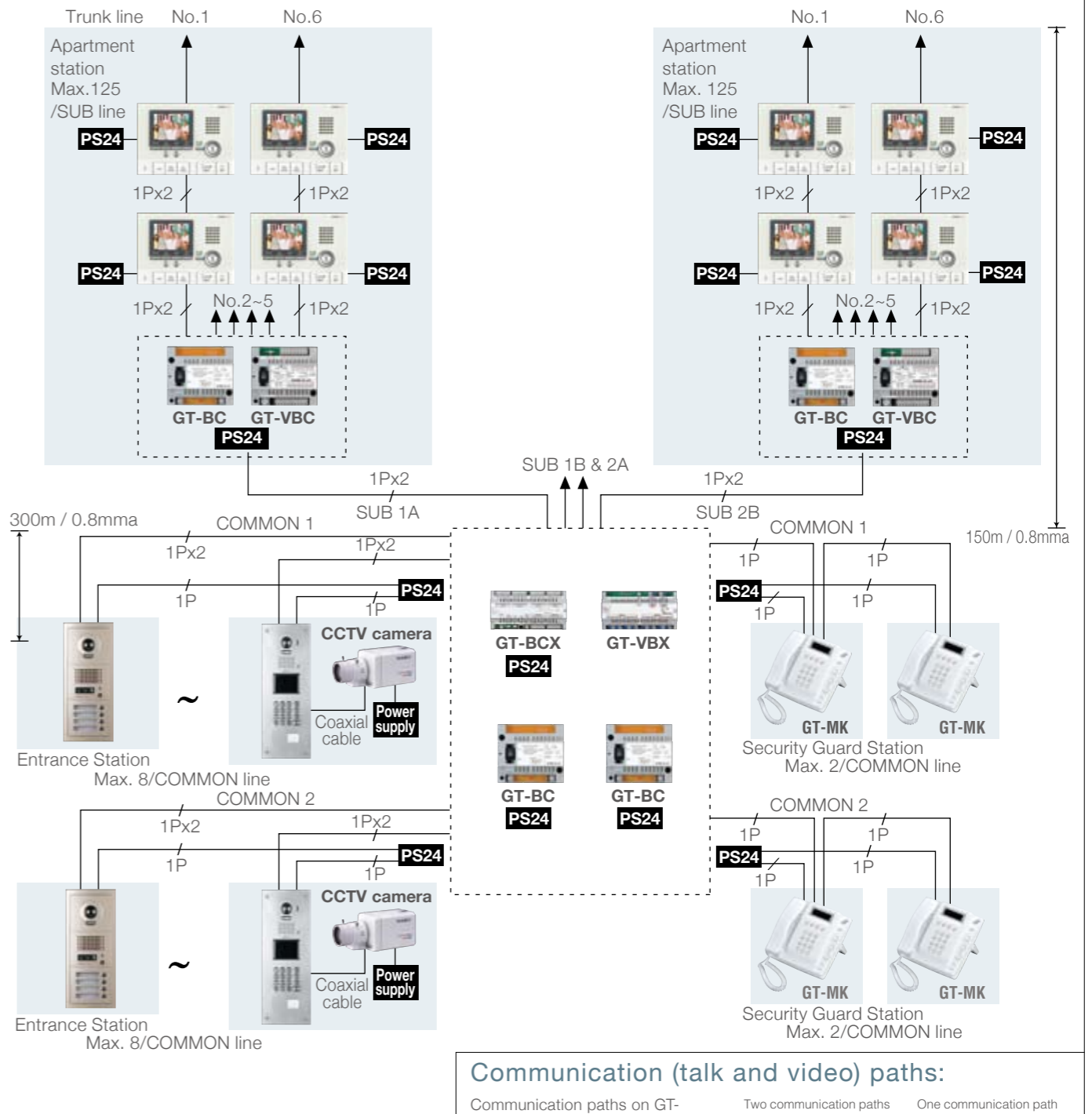

Communication (talk and video) paths:

Communication paths on GT-BCX and GT-VBX are identified as "COMMON 1" and "COMMON 2". Each related COMMON-SUB trunk has its own communication path that can be used within itself for communication between Entrance and Resident. Crossover to the other trunk is possible, but this will occupy both talk and video paths. Also Security Guard communication occupies an entire system.

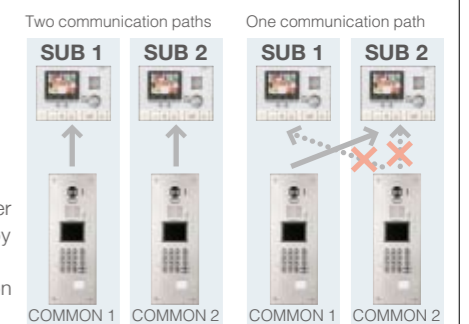

Hands-Free Color Video Apartment System with Recording, Zoom & PanTilt features

Audio system (without camera or monitor) is available.

Entrance station

All-in-one type
Digital name scrolling

GT-DM
Entrance station with camera with name scroll

Module type
Direct-select call button

The directory button panels back-lit display illuminates resident's name or unit number

Digital name scrolling

Audio Module

GT-DP Audio panel for GT-DA
GT-DP-L Audio panel for GT-DA-L
GT-DA Audio module
GT-DA-L Audio module w / guide display

Option

GF-AP Address panel
GF-AD Address module
GF-BP Blank panel

Call switch Module

GF-1P 1-call panel
GF-2P 2-call panel
GF-3P 3-call panel
GF-4P 4-call panel
GT-SW Call switch module

Camera Module

GT-VP Camera panel
GT-VA Camera module

Digital name scrolling module

GT-NSP-L Display module panel
GT-NS Digital name scroll display module

Access control keypad module

GT-AC Access control keypad module

Front frame & back box

GF-10KP 10-key module panel
GT-AD 10-key module panel

GT-4F 4-module front frame
GT-3F 3-module front frame
GT-2F 2-module front frame

GT-4B 4-module back box
GT-3B 3-module back box
GT-2B 2-module back box

GT-nHB Hooded surface-mount box
GT-nH Rain hood
GF-nBA Surface-mount box

Entrance station components

Number of calling button		4.	8.	12.	16.	20.	24.	25.-48.	GH-NS, GF-10K
(1)	GT-VA GT-VP	1 1	1 1	1 1	1 1	1 1	1 1	For more than 7 X GH-SW, install additional power supply & special device required. Contact local ALPHONE distributor	1 1
(2)	GT-DP(-L) GT-DA(-L)	1 1	1 1	1 1	1 1	1 1	1 1		1 1
(3)	GT-SW GF-4P	1 1	2 2	3 3	4 4	5 5	6 6		- -
(4)	GF-3F GF-3B	1 1	- -	2 2	2 2	- -	3 3		- -
(5)	GT-4F GT-4B	- -	1 1	- -	- -	2 2	- -		1 1
(6)	GF-BP GT-AD GF-AP	- - -	- - -	1 - -	- - -	1 - -	- -		- -
(7)	GT-NS GT-NSP-L GT-10K GF-10KP	- - - -	- - - -	- - - -	- - - -	- - - -	- - - -		1 1 1 1

Residential station

GT-2C-L Monitor apartment master station w/ picture memory
GT-2C Monitor apartment master station w/ picture memory
GT-1M-L Monitor apartment station
GT-2H-L Monitor apartment sub master station
GT-2H Monitor apartment sub master station
GT-1A Audio apartment station
GT-1C-L Monitor apartment station
GT-1C Monitor apartment station
GT-HS Optional Handset
GT-1D Audio apartment station

Video door station

JK-DA Wide and Zoom & PanTilt Vandal-resistant video door station, surface mount
JK-DV Wide and Zoom & PanTilt Vandal-resistant video door station, surface mount
JK-DVF Wide and Zoom & PanTilt Vandal-resistant video door station, flush mount

Door station

GT-D Audio only door station

Residential station

GT-MK Security guard station
GFW-S Desk-top stand

Control units

GT-BC Bus control unit
GT-VBC Video Bus control unit, expander video control
GT-4Z Video 4-zone divider

Expanded control units

GT-BCX Expanded Bus control unit
GT-VBX Expanded video control unit
PS-2420 (without AC cord)
PS-2420S
PS-2420UL

Option

GT-RY External signaling relay entrance light, external buzzer
W-DIN11 DIN mounting rail for GT-BC, GT-VBC, GT-4Z
AC-10S Access control keypad, surface mount
AC-10F Access control keypad, flush mount
GTW-LC Lift control adaptor
AE7090220B
AE7090220G
AE7090210B
AE7090210G
ALPHONE approved product wire