

GM Series
APARTMENT AUDIO/VIDEO ENTRY SECURITY SYSTEM

GM SYSTEM

INSTALLATION MANUAL

This Installation Manual is supplied with **GM-8A** Main Control Unit, and contains information on all the GM system models:

- **GM-8B**: Sub Control Unit.
- **GM-4V**: Video distributor.
- **GW-V/VP**: Camera module.
- **GW-D/DP**: Speech module.
- **GW-1~4P**: Switch module.
- **GM-1MD**: Apartment monitor/audio station.
- **GM-1D**: Apartment audio-only station.

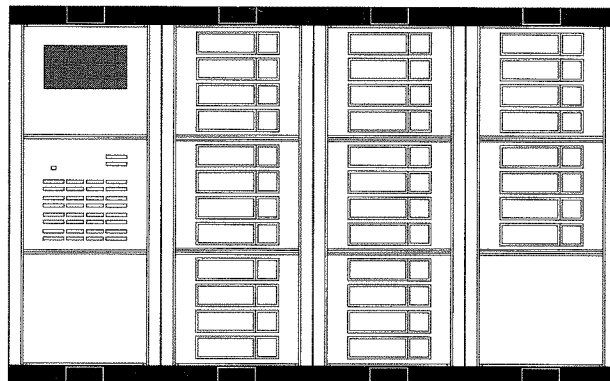
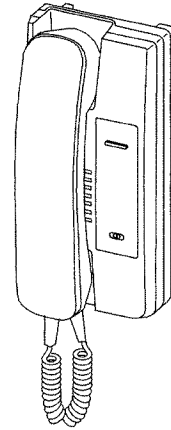
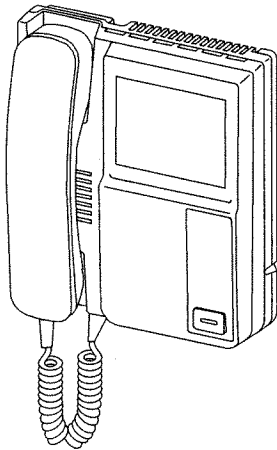

CONTENTS

Contents	2
Precautions on Installation & Wiring	3
1. System Outline & Models	4 - 7
■ System Outline	4
■ Models available	5
■ GM Model Selection Table	6 - 7
2. Names & Features	8 - 9
■ Names	8
■ Features	9
3. Installation & Wiring	10 - 18
■ Cable installation	10
■ Image viewing area, etc.	11
■ Terminal block layout	12 - 14
■ Wiring diagrams	14 - 18
• 4-call Audio-only entrance station	14
• 8-call, Audio/video entrance station	15
• 12-call, Audio/video entrance station	15
• 24-call, Audio/video entrance station	16
• Apartment trunk line via GM-4V's	17
• Apartment stations	18
4. Mounting	19 - 21
5. Operations GM SYSTEM	22
6. Technical Precautions	23
7. Specifications	24

GM Series INSTALLATION MANUAL

This Manual is contained with GM-8A Main Control Unit of GM Apartment Audio/Video Entry Security System.

Before actually installing GM equipment, the contents of this Manual must be thoroughly read and understood.



PRECAUTIONS ON INSTALLATION & WIRING

⚠ : WARNING
(Negligence could result in death or serious injury to people)

⚠ : GENERAL PRECAUTIONS

⊘ : General prohibitions.

⊘ : Prohibitions to subject the unit to water.

⚠ : CAUTION
(Negligence could result in injury to people or damage to property)

⊘ : Prohibitions to dismantle the unit.

⚡ : Take the unit to earth ground

⚠ WARNING

1. The GM equipment is an electrical device, whose wiring must be made by qualified personnel. ⊘
2. Do not change or modify GM equipment. ⊘
3. Do not connect any power source other than specified to terminals +, - on GM-8A. ⊘
Doing so can cause fire or damage the unit.
4. The GM equipment must not be exposed to water or any other liquid. ⊘
5. Do not open GM-1MD monitor unit. The high voltage is inside. ⊘
6. Make sure wires are connected properly before plugging in the power supply. ⊘
7. Keep AC outlet away from moisture and dust.
8. Do not put any forcible strength on the monitor of GM-1MD. ⊘
It can cause injury.

⚠ CAUTION

1. Do not install or make any wire terminations while power supply is turned on. It can cause electrical shock or damage the unit.
2. Mount the GM-1MD monitor on wall in a convenient location, but not where it could be bumped or jarred.
3. Do not install GM components in any of the following locations, as it may cause the system to malfunction;
 - High or extreme cold temperature area: under direct sunlight, near equipment that varies in temperature, in front of air-conditioner, inside a refrigerated area, etc.
 - Places subject to moisture or humidity extremes.
 - Places subject to environmental conditions, such as oil, dust, chemicals, salt, etc. ⊘
 - Places subject to constant vibration or impact.

⚠ GENERAL PRECAUTIONS

1. GM equipment, except for GW entrance panel, is designed for indoor use only. Do not install outdoors.
2. GM system is not operable during a power failure.
3. In areas where broadcasting station antennas are close by, intercom system may be affected by radio frequency interference.
4. Keep all DC wiring at least 30cm, 20" away from AC 100 ~ 240V wiring, fluorescent lighting, or dimmer switches. Otherwise, cross AC wiring at a 90° angle.
5. Severe weather conditions, such as lightning storms, may cause damage to GM equipment. We recommend that power surge protection be installed as follows: (However, this does not guarantee that no damage will occur).

⚡ If the power supply has a GROUND terminal, take it to an earth ground. In this case, a separate surge arrester is not necessary. When using a power supply that has no GROUND terminal, install a surge arrester near the output as shown. Install a surge-arrester at a point close to the output, taken to earth ground. *

Discharging voltage: 100 ~ 180V

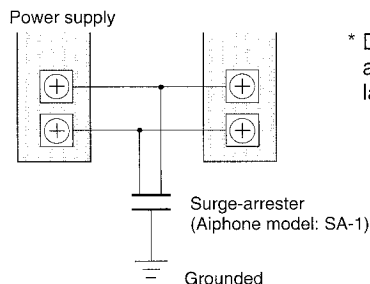

* Door release terminals: 1EL, 1EL and 2EL, 2EL (on GM-8A), and lamp sockets (on GW-1P~4P).

1 System Outline & Models

GM series is a max. 24-station Apartment Audio/Video Entry Security System, with one or two Entrance stations w/access control.

Entrance panel consists of 3 modules: Camera, Speech and Call switches, allowing to mount an exactly required number of buttons. Complies with 5 types of apartment station needs, each with call extension option.

■ System Outline: 8-station system

■ Package Contents

- Main control unit (GM-8A)
 • Installation Manual
 Sub control unit (GM-8B)
 • Connectors

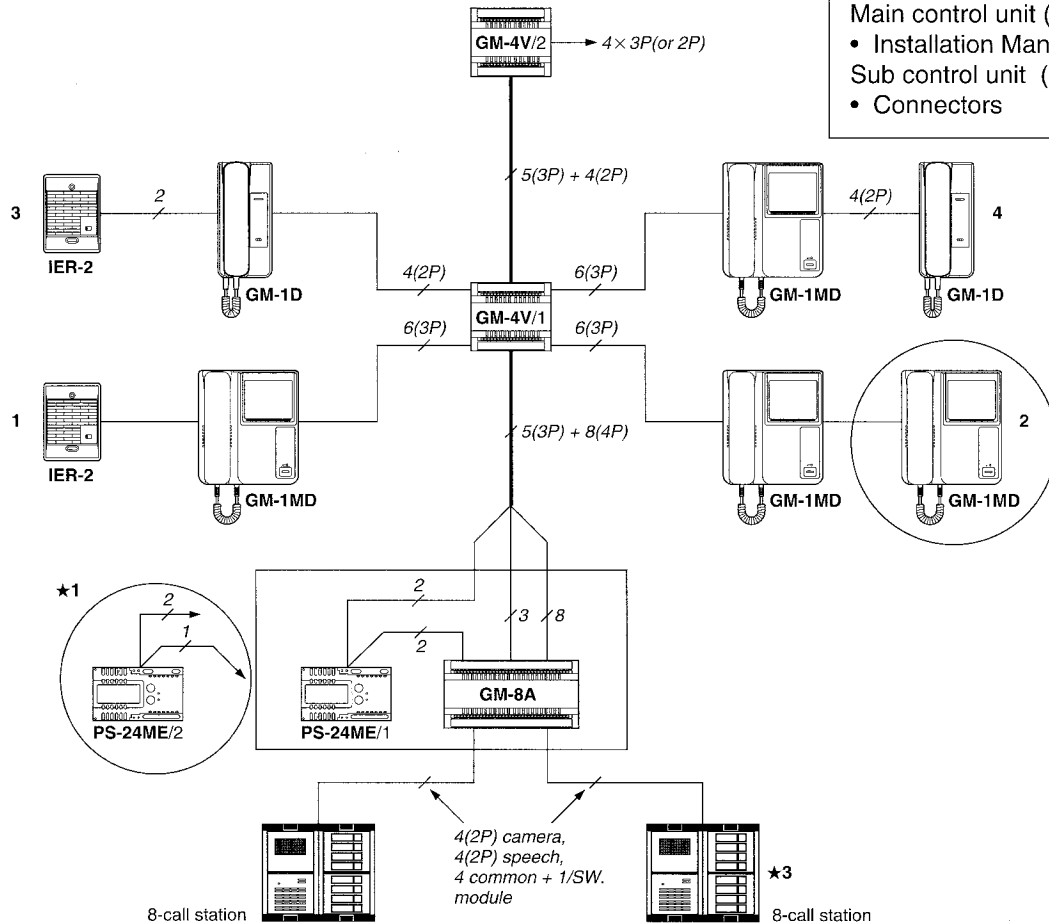

1. Five combinations of apartment stations, including two GM-1D's

- Chime tone & image call annunciation
- No calling between rooms
- Optional chime extension speaker to each station

2. One or two Video Entrance stations

- Calling, 45 sec. & communication 2-1/2 min. timed
- Access control at communicating entrance
- Single & non-open channel blocks out a call at Entrance 2 (Occupied LED indication)

- ★1 Only when two GM-1MD monitor stations are used in an apartment(s), an additional power supply PS-24ME 2 is required for trunk line (with a minus wire to PS-24ME 1). At that time, PS-24ME 1 only powers GM-8A.

⚠ Do not connect + to + terminals on two power supplies.

- ★2 ⚠ Door strike & lamp 12V AC power wires (not shown) must be separately run from audio/video wires.

- ★3 The second entrance station can be audio only.

■ Models available

A. Entrance call Panels:

1. Camera module 2. Speech module 3. Blank panel 4. Address panel

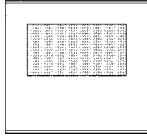

GW-V & GW-VP

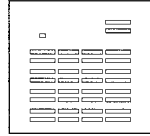

GW-D & GW-DP



GW-0P

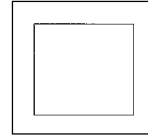

GW-A

Each camera and speech unit is mounted to panel with 4 screws.

5. Switch module

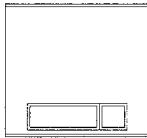

GW-1P

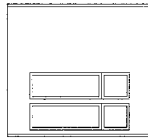

GW-2P



GW-3P

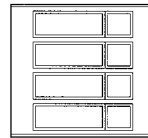

GW-4P

★ A metal plate reinforces back box after fixed in the wall. Remove the plate when mounting the modules.

Entrance Call Panel consists of 3 modules, mounting frames with back boxes.

1. Camera unit **GW-V** & Panel **GW-VP**
2. Speech unit **GW-D** & Panel **GW-DP**
3. Blank panel **GW-0P**
4. Address panel **GW-A**
5. Switch module **GW-1P, GW-2P, GW-3P, GW-4P** (w/lamp)
6. Mounting frames **GW-2, GW-3**, each w/back box (*)

6. Mounting frames

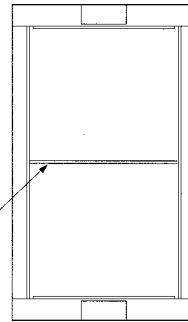

GW-2

2-section frame

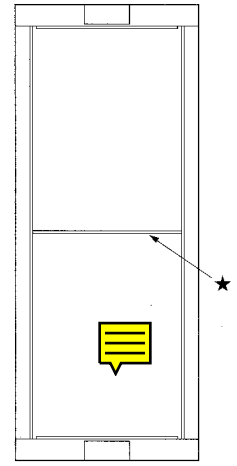

GW-3

3-section frame

(*) With GW-2 & GW-3, are included 8 name cards & cover opener, 2 joint parts, tamper-proof screwdriver & built-in back box.

B. Control units



GM-8A

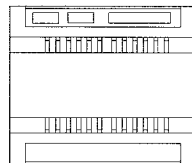

GM-8B (max. 2)

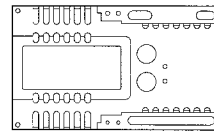

PS-24ME

GM-8A main & **GM-8B** sub control unit(s) are mountable on DIN rail.

Plug in connector supplied with **GM-8B**. **PS-24ME** DC 24V, 0.9A power supply, DIN mountable, includes AC 230V lines input terminals or **PS-24E** DC 24V, 2A power supply, single-gang mounting, AC 220-240V input.

C. Apartment stations



GM-4V

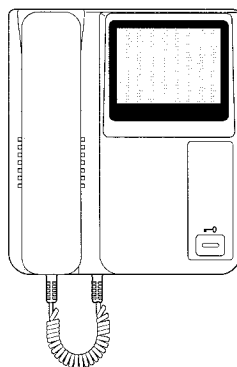

GM-1MD

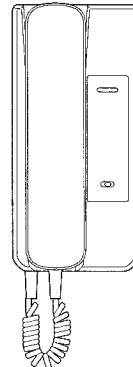

GM-1D









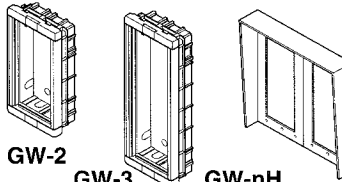
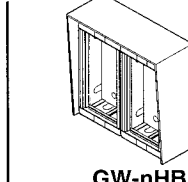

IER-2

GM-4V: Video distributor for 4 outputs.
GM-1MD monitor/audio & **GM-1D** audio-only stations each with door release button.
IER-2: Optional speaker for remote chime extension with 3 positions volume control.

GM Model selection table

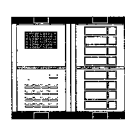

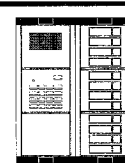
ENTRANCE STATION

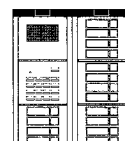
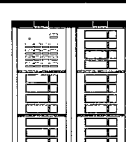
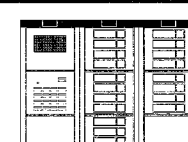
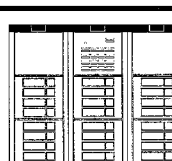
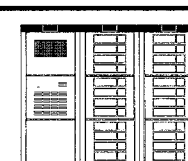
Below table is to assist you to determine quantity required for Audio-only or Video Entrance station. GW-nHB, Outside Surface mount Box w/Hood is available with GW-2 or GW-3 Frame. Unit: piece (audio-only or audio/video)

Modules & Frames	Camera	Speech	Blank or Address panel	1-call	2-call	3-call	4-call	Frames, Outside Hood or Surface Box w/Hood	
	<i>For video</i>							<i>Semi-flush mounting</i>	<i>Surface-mounting</i>
Capacity	GW-V GW-VP	GW-D GW-DP	GW-0P or/& GW-A	GW-1P	GW-2P	GW-3P	GW-4P	 GW-2 GW-3 GW-nH	 GW-nHB
1-call	0/1 pce	1 pce	—	1 pce	—	—	—	<i>4-call audio only</i>  GW-2 (w/GW-002H) or GW-002HB	<i>Audio/video</i>  GW-3 (w/GW-003H) or GW-003HB
2-call	0/1	1	—	—	1	—	—		
3-call	0/1	1	—	—	—	1	—		
4-call	0/1	1	—	—	—	—	1		
5-call	0/1	1	—	1	—	—	1	<i>8-call audio only</i>  GW-3 (w/GW-003H) or GW-003HB	<i>Audio/video</i>  2x GW-2 (w/GW-202H) or GW-202HB
6-call	0/1	1	—	—	1	—	1		
7-call	0/1	1	—	—	—	1	1		
8-call	0/1	1	—	—	—	—	2		
9-call	0/1	1	0/1	1	—	—	2	<i>12-call audio only</i>  2x GW-2 (w/GW-202H) or GW-202HB	<i>Audio/video</i>  2x GW-3 (w/GW-203H) or GW-203HB
10-call	0/1	1	0/1	—	1	—	2		
11-call	0/1	1	0/1	—	—	1	2		
12-call	0/1	1	0/1	—	—	—	3		
13-call	0/1	1	1/0	1	—	—	3	<i>16-call audio only</i>  2x GW-3 (w/GW-203H) or GW-203HB	<i>Audio/video</i>  2x GW-3 (w/GW-203H) or GW-203HB
14-call	0/1	1	1/0	—	1	—	3		
15-call	0/1	1	1/0	—	—	1	3		
16-call	0/1	1	1/0	—	—	—	4		
17-call	0/1	1	0/2	1	—	—	4	<i>20-call audio only</i>  2x GW-3 (w/GW-203H) or GW-203HB	<i>Audio/video</i>  3x GW-3 (w/GW-303H) or GW-303HB
18-call	0/1	1	0/2	—	1	—	4		
19-call	0/1	1	0/2	—	—	1	4		
20-call	0/1	1	0/2	—	—	—	5		
21-call	0/1	1	2/1	1	—	—	5	<i>24-call audio only</i>  3x GW-3 (w/GW-303H) or GW-303HB	<i>Audio/video</i>  3x GW-3 (w/GW-303H) or GW-303HB
22-call	0/1	1	2/1	—	1	—	5		
23-call	0/1	1	2/1	—	—	1	5		
24-call	0/1	1	2/1	—	—	—	6		

CONTROL UNITS & APARTMENT STATIONS

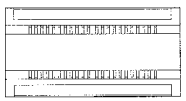
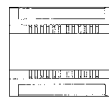
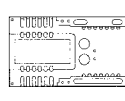
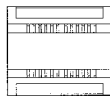
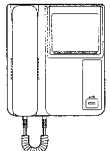
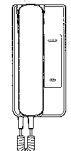
Unit: Pce

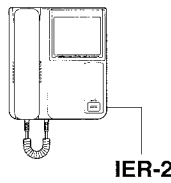
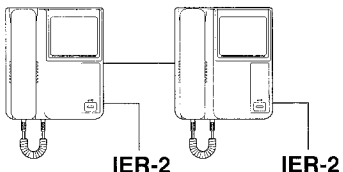
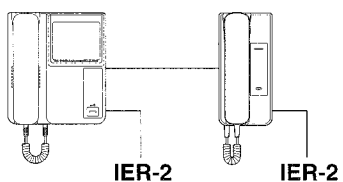
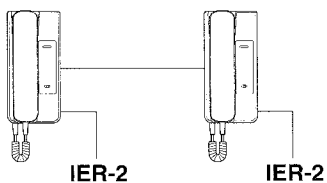
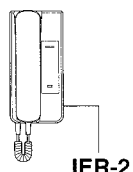
Modules & Frames Capacity	Control Units		Power Supply	Video Distributor	Apartment Stations		
	 GM-8A Main	 GM-8B Sub	 PS-24ME	 GM-4V	 Monitor/Audio GM-1MD	 GM-1D	 Call ext. IER-2
1-call	1	—	1 (*)	1	Select from 5 combination examples as below;		
2-call	1	—	1 (*)	1			
3-call	1	—	1 (*)	1			
4-call	1	—	1 (*)	1			
5-call	1	—	1 (*)	2			
6-call	1	—	1 (*)	2			
7-call	1	—	1 (*)	2			
8-call	1	—	1 (*)	2			
9-call	1	1	1 (*)	3			
10-call	1	1	1 (*)	3			
11-call	1	1	1 (*)	3			
12-call	1	1	1 (*)	3			
13-call	1	1	1 (*)	4			
14-call	1	1	1 (*)	4			
15-call	1	1	1 (*)	4			
16-call	1	1	1 (*)	4			
17-call	1	2	1 (*)	5			
18-call	1	2	1 (*)	5			
19-call	1	2	1 (*)	5			
20-call	1	2	1 (*)	5			
21-call	1	2	1 (*)	6			
22-call	1	2	1 (*)	6			
23-call	1	2	1 (*)	6			
24-call	1	2	1 (*)	6			

(*) Another PS-24ME is required when an apartment(s) has two GM-1MD monitor/audio station.

2 NAMES & FEATURES

■ Entrance station

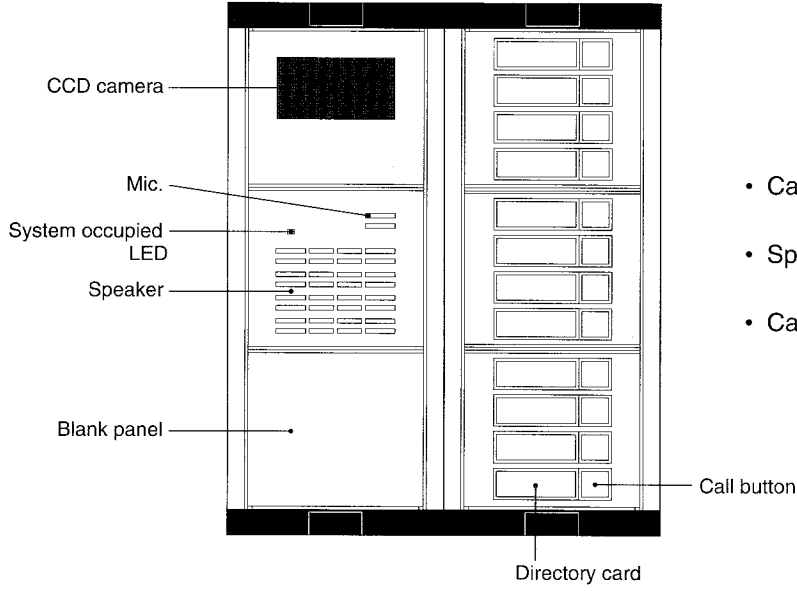

12-call video entrance station

- Camera module
* Infrared LEDs mounted.
- Speech module
* Occupied LED is lit on the Panel.
- Call switch module
* Directories are backlit by a lamp inside.

■ Apartment stations

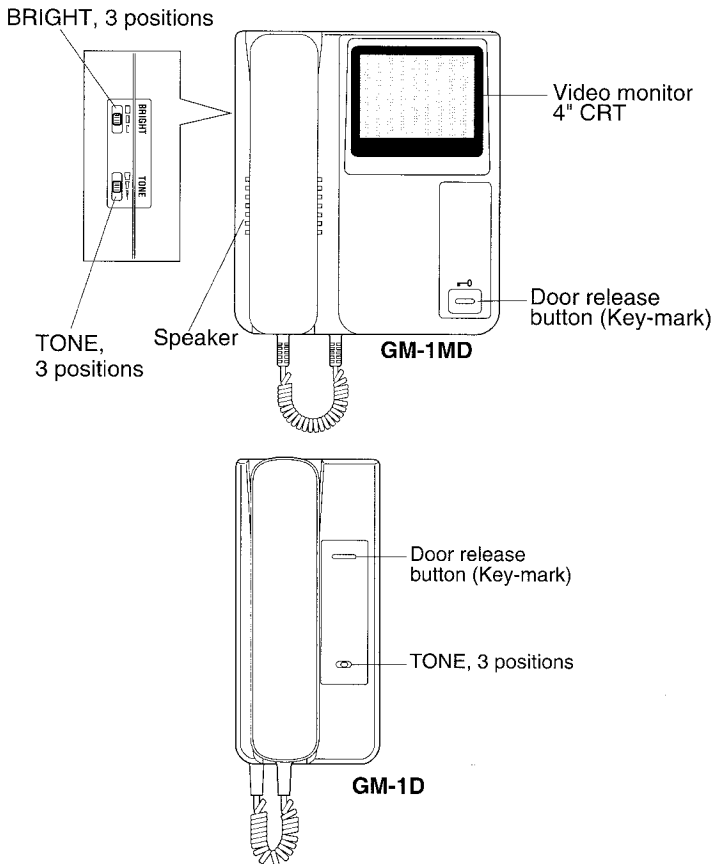

Call extension

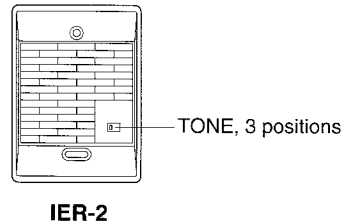

■ GM System Features

1. Max. 24 residential stations.
2. System consists of Main & Sub control unit(s), Entrance call panel(s), Video distributor (floor), and Apartment station(s).
3. Fully modular Entrance station. Mounts on GW-2 or GW-3 frames.
4. **One or two Entrance call panels with camera.**
 - Second Entrance station can be Audio-Only.
 - Anodized aluminum panel w/tamper-proof screws
 - Camera module with infrared LED's for clearer visualization in poor lighting.
 - Speech module with OCCUPIED LED.
 - Call button modules 1 ~ 4 calls with a lamp for directories backlighting.
 - ★ Requires one or two AC 12V lamp power supply(ies).
5. Trunk wiring: 3P(*) via video distributors + No. of apartments risen from Main/Sub Control unit. (*) 3P: 5wires
 - Main control unit for up to 8 stations.
 - Sub control unit(s) for additional 8 stations.
 - One power supply PS-24ME for entire system.
 - ★ Install another power supply when two monitor/audio stations are used within an apartment(s).
 - All units are DIN rail mountable.
6. **One or two Audio/monitor stations per apartment.**
 - Video distributor provides four 3P cable run to apartment stations. (2P for audio-only station)
 - One or two monitor/audio stations
 - One each monitor/audio and audio-only stations
 - One or two audio-only stations
7. Call extension speaker. One per apartment station.
8. Selective control of door strike at a communicating entrance panel.
 - ★ Requires a separate AC transformer.

3 INSTALLATION & WIRING

■ Cable installation

24-station system

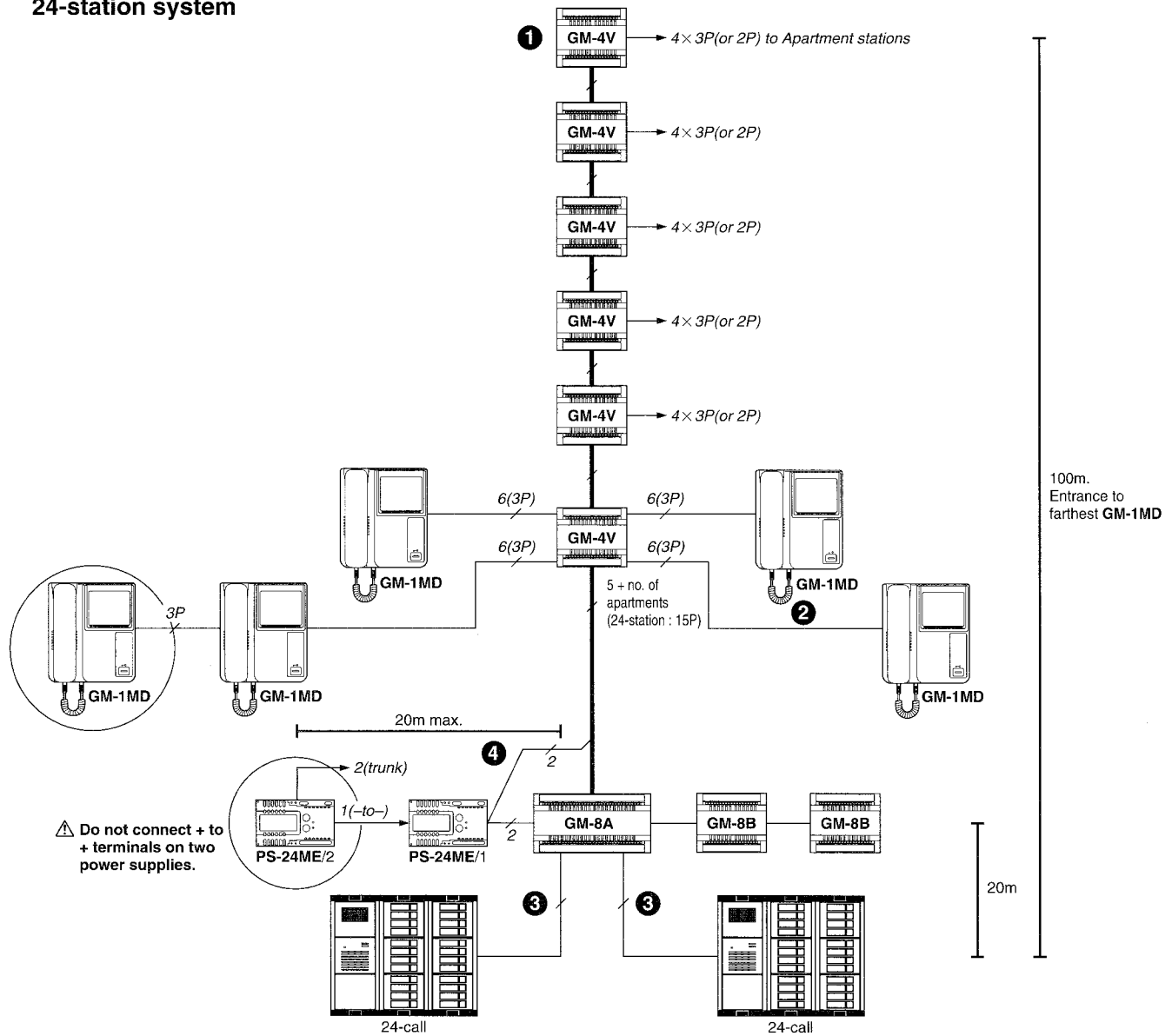

■ Cable requirements: Use twisted pair cable for any wiring block

No.	BLOCK	NO. OF WIRES
①	Apartment trunk cable (GM-8A to GM-4V)	3P (5 used) + n (n = no. of apartments)
②	Individual apartment station	3P for GM-1MD, or 2P for GM-1D
③	Entrance (ea.) to Control (GM-8A)	2P (4 cond.) Camera Module 2P (4 cond.) Speech Module 4 common +1/Call Sw. Module ★ A 1 & A 2 terminals MUST be wired in a pair.
④	PS-24ME/1 to Control (GM-8A)	2 wires +, - to ea. GM-8A & apartment trunk ★ When two GM-1MD stations are installed in an aptmt(s); PS-24ME1 powers only GM-8A. PS-24ME2 runs 2 wires in the trunk cable. Connect a - - wire between PS-24ME 1 & 2.

3 INSTALLATION & WIRING

Image viewing area

GW-V camera module employs a wide-angle lens, which views 70° horizontally and 95° vertically. By the camera angle lever, camera is turned up or downward by 10°.

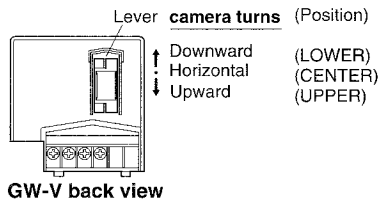

When camera is positioned horizontally;

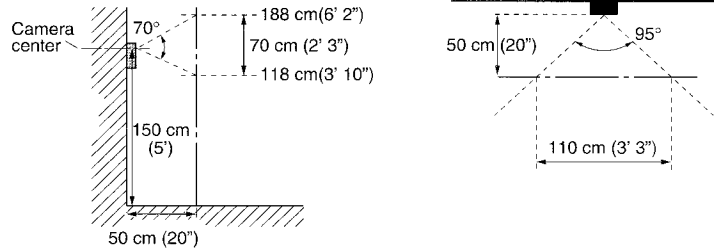

Connectors between GM-8A and GM-8B's

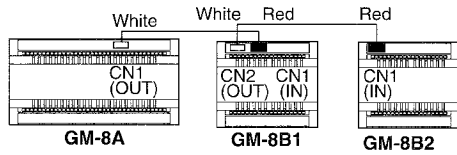

For more than 8 to max. 24 stations, GM-8A needs one or two GM-8B sub control unit(s), in order to run individual call wires to GM-4V distributors. Interconnects with supplied plug-in connectors.

Type of Entrance station 2

When GM system includes two entrance panels, SW2 on GM-8A control unit determines type of Panel, A: Audio only B: Audio/Video.

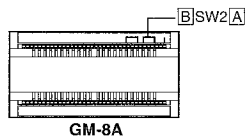

One or two apartment stations

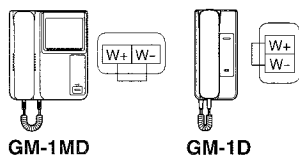

When an apartment has two stations installed, either monitor/audio or audio-only, **remove a link between W+ and W- on both stations.**

Reset switch

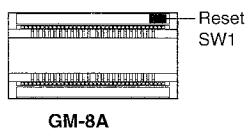

Press RESET switch, when system malfunctions. After PS-24ME power supply is turned off and on, system initializes itself.

Video impedance matching (GM-1MD)

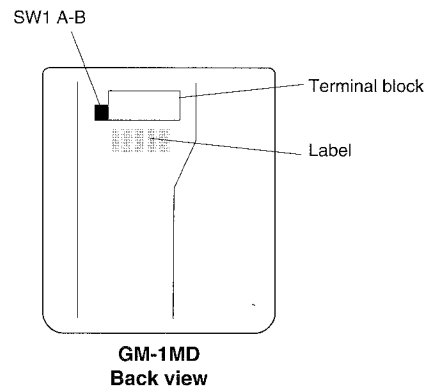

When two monitor stations are installed, set the SW1 on the GM-1MD.

- A: 75Ω (second monitor station)
- B: HIGH (first monitor station)

When only one monitor is installed, set SW1 to A position always.

Call extension IER-2

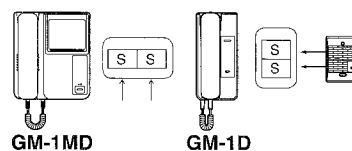

GM-1MD & GM-1D have S, S terminals for chime tone output. **One IER-2 speaker per station** can be connected.

Door strike EL-9S

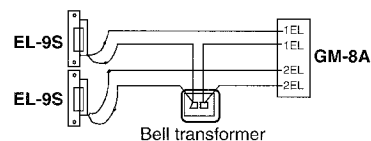

Terminals 1EL, 1EL (for Entrance 1) & 2EL, 2EL (for Entrance 2) provides dry contact closure contact for door release (Aiphone model: EL-9S, 12V AC, 0.35A). Door strike takes place at communicating entrance only.

3 INSTALLATION & WIRING

■ Terminal block layout

● GM-8A

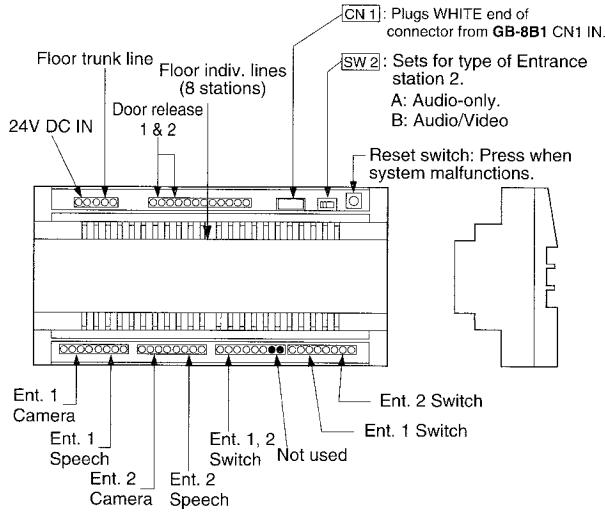

• Upper terminals block

- +,- :** DC input
- B1,B2 :** Video signal output
- H :** Control output
- 1EL,1EL :** Door release output (dry closure contact for Entrance 1)
- 2EL,2EL :** Door release output (dry closure contact for Entrance 2)
- 1 - 1, 2, 3, 4 :** Apartment call line (GM-4V#1)
- 2 - 1, 2, 3, 4 :** Apartment call line (GM-4V#2)

• Lower terminals block

(For Entrance 2)

- 1V+,1V- (2V+, 2V-):** Camera power supply output
- 1A1, 1A2 (2A1, 2A2):** Video signal input
- 1D+,1D- (2D+, 2D-):** Speech power supply output
- 1TR (2TR):** Communication
- 1MC (2MC):** Mic. control output
- U1 ~ U6 :** Entrances 1 & 2 switch common
- 1C1 ~ 1C4 :** Entrance 1 switch No. input
- 2C1 ~ 2C4 :** Entrance 2 switch No. input

• Terminal label

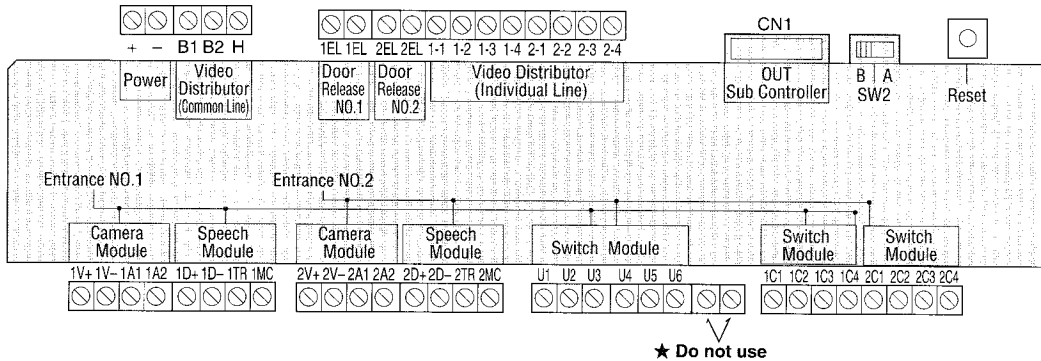

● GM-8B

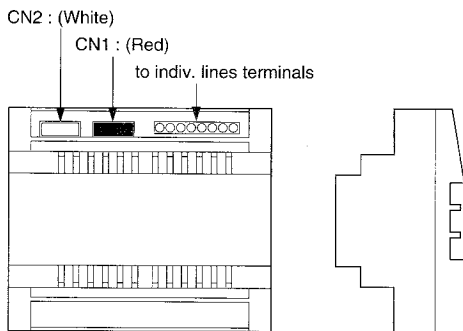

• Terminal label

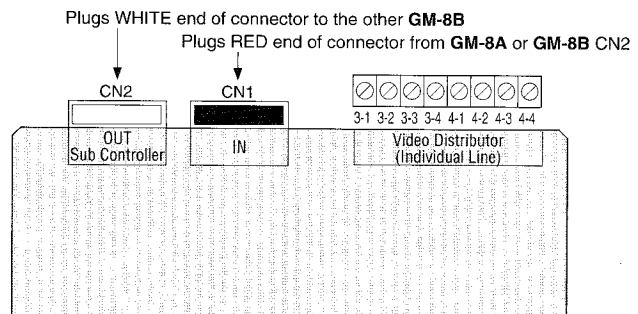

- 3-1 ~ 4** } Individual line to GM-4V (2 units)
- 4-1 ~ 4** }

3 INSTALLATION & WIRING

■ Terminal block layout

● GM-4V

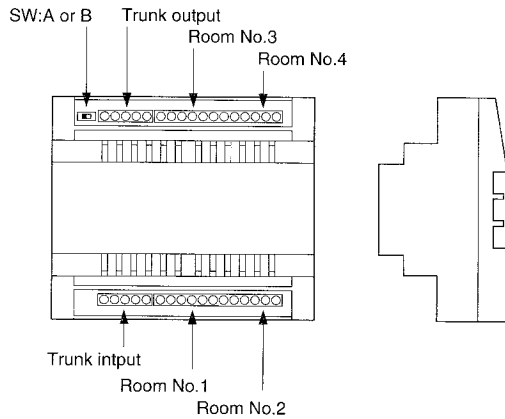

- **Upper terminal block**
 - +,- : 24V DC output
 - B1, B2 : Video only trunk output
 - H : Control output
 - +,- : 24V DC output
 - 3B1, 3B2 : Video only individual output (4B1, 4B2)
 - H : Control output
 - 3C : Individual call input/output (4C)
- **Lower terminal block**
 - +,- : 24V DC input
 - A1, A2 : Video only trunk input
 - H : Control input
 - +,- : 24V DC output
 - 1B1, 1B2 : Video only individual output (2B1, 2B2)
 - H : Control output
 - 1C : Individual call input/output (2C)

• Terminal label

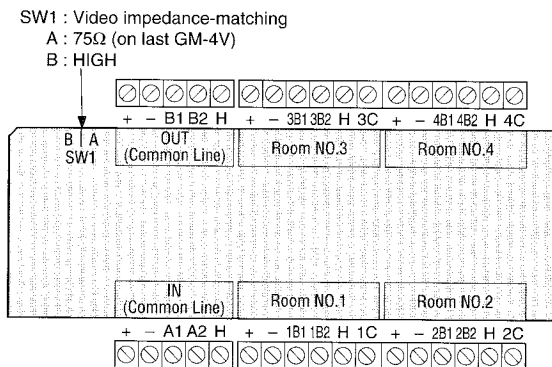

● GM-1MD

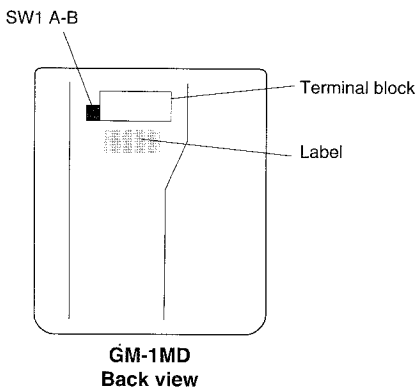

- +,- : 24V DC input
- A1, A2 : Video signal input
- H : Control input
- C : Individual call/communication input/output
- S, S : Chime signal output
- W+, W- : Communication impedance matching
- Link may remain attached on one and only station.
- SW1 : Video impedance matching
 - A : 75Ω (second of two GM-1MD's)
 - B : HIGH (first of two GM-1MD's)
- ★ Do not change A setting on one and only GM-1MD.

● GM-1D

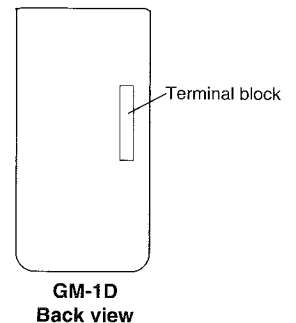

3 INSTALLATION & WIRING

Entrance station modules

GM-8A Main Control Unit runs a cable(s) to Video Entrance station in the following details;

- * 4 wires from GW-V/VP camera module (V+, V-, A1, A2).
- * 4 wires from GW-D/DP speech module (D+, D-, TR, MC)
- * Max 10 wires from GW-1~4P call switch of up to 24 stations.

● GW-V

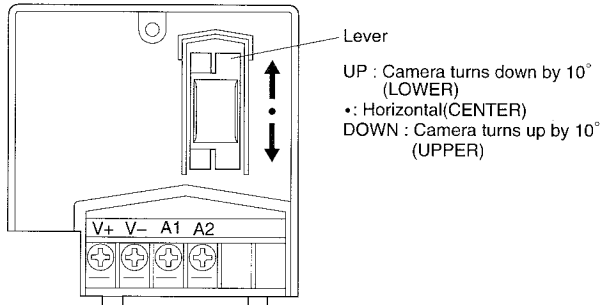

V+,V- : Power supply input
A1, A2 : Video signal output

● GW-D

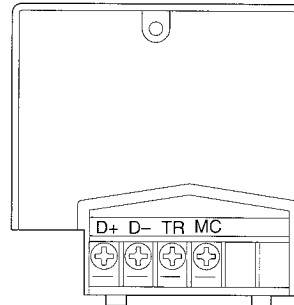

D+,D- : Power supply input
TR : Communication
MC : Mic. control input

★ The camera & speech modules are available with GW-VP & GW-DP panels mounted.

● GW-1P ~ 4P

As to GW-1~4P call switches, it is the general idea that one wire (common) is connected to upper terminal of call switch on top from U1 ~ U6 terminals.

And 4 parallel wires are connected from 1C1 ~ 4 terminals to lower terminal of each call switch (numbered 1 ~ 4 in the diagram), which goes to the next or down to below switch modules.

APARTMENT STATION NUMBER CHART

No.	GM-8A INPUT(Ent.)	GM-8A, 8B OUTPUT(GM-4V)	GM-4V OUTPUT(Apt.)
1	U1	GM-8A	ROOM 1C
2			1-1
3			1-2
4			1-3
5	U2	GM-8A	ROOM 1C
6			2-1
7			2-2
8			2-3
9	U3	GM-8B 1	ROOM 1C
10			3-1
11			3-2
12			3-3
13	U4	GM-8B	ROOM 1C
14			4-1
15			4-2
16			4-3
17	U5	GM-8B 2	ROOM 1C
18			3-1
19			3-2
20			3-3
21	U6	GM-8B	ROOM 1C
22			4-1
23			4-2
24			4-3

WIRING DIAGRAMS

■ 4-call Audio-only entrance station

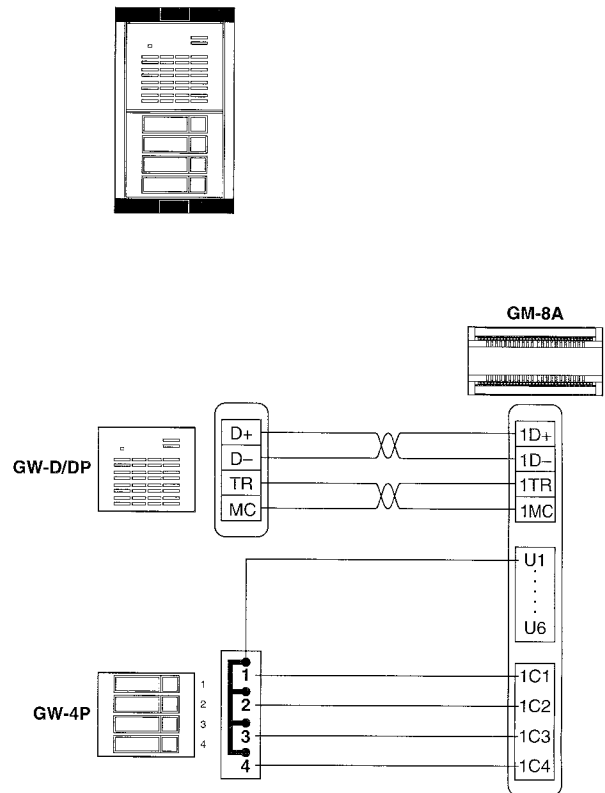

WIRING DIAGRAMS

● 8-call, Audio/video entrance station

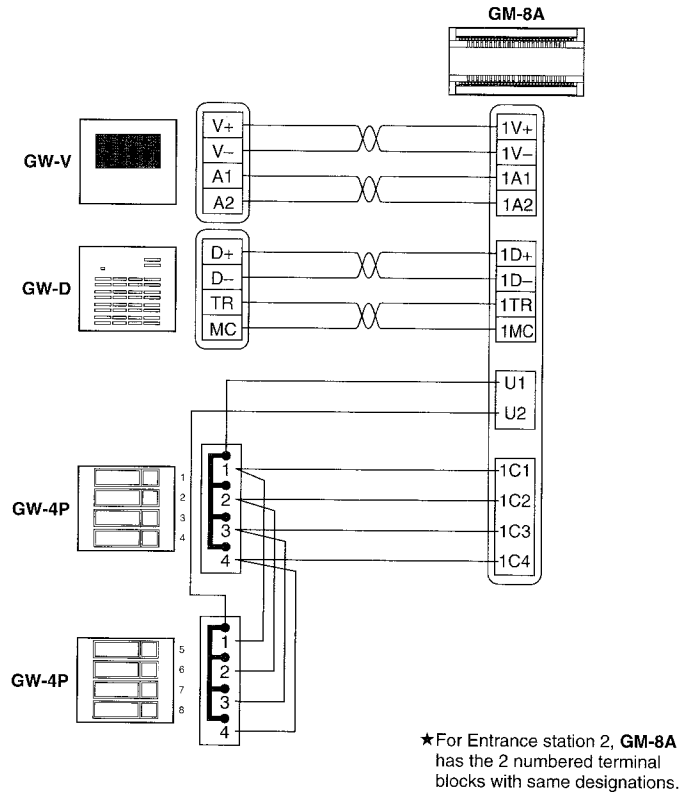
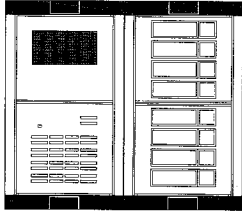

● 12-call, Audio/video entrance station

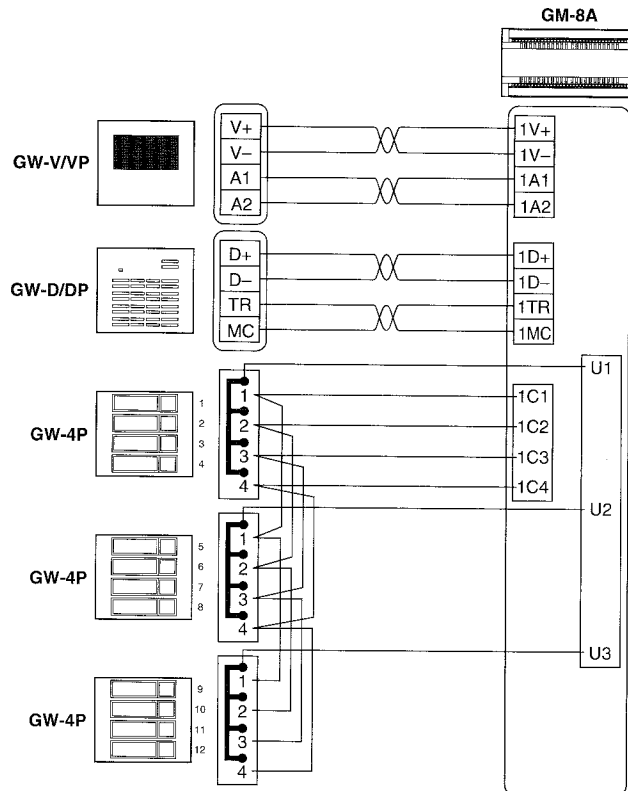
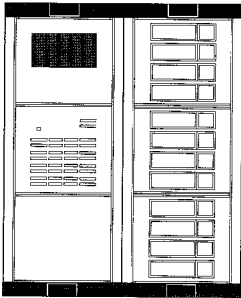

WIRING DIAGRAMS

● 24-call, Audio/video entrance station

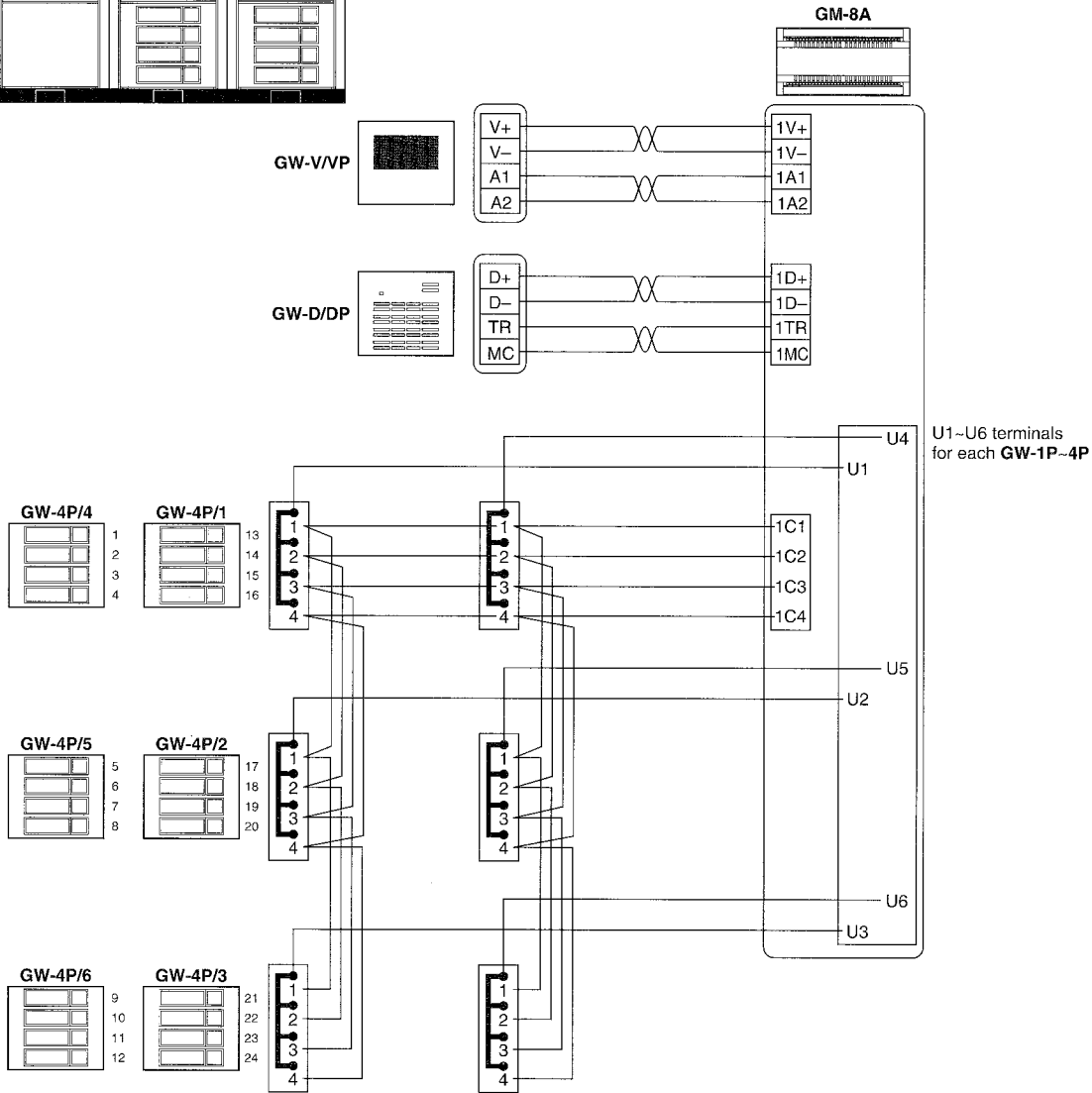
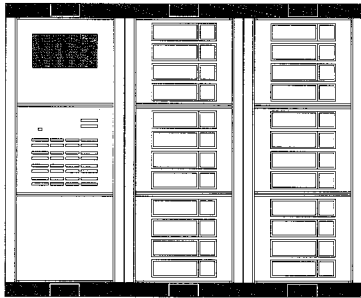

● Door strike

Separately from audio/video signal lines, run 2 wires to the door strike of Entrance 1 and 2. Single bell transformer may be used to power door strike.

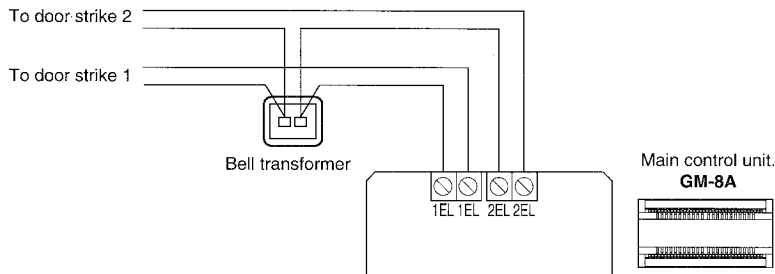

WIRING DIAGRAM

● Wiring from GM-8A to GM-4V trunk line

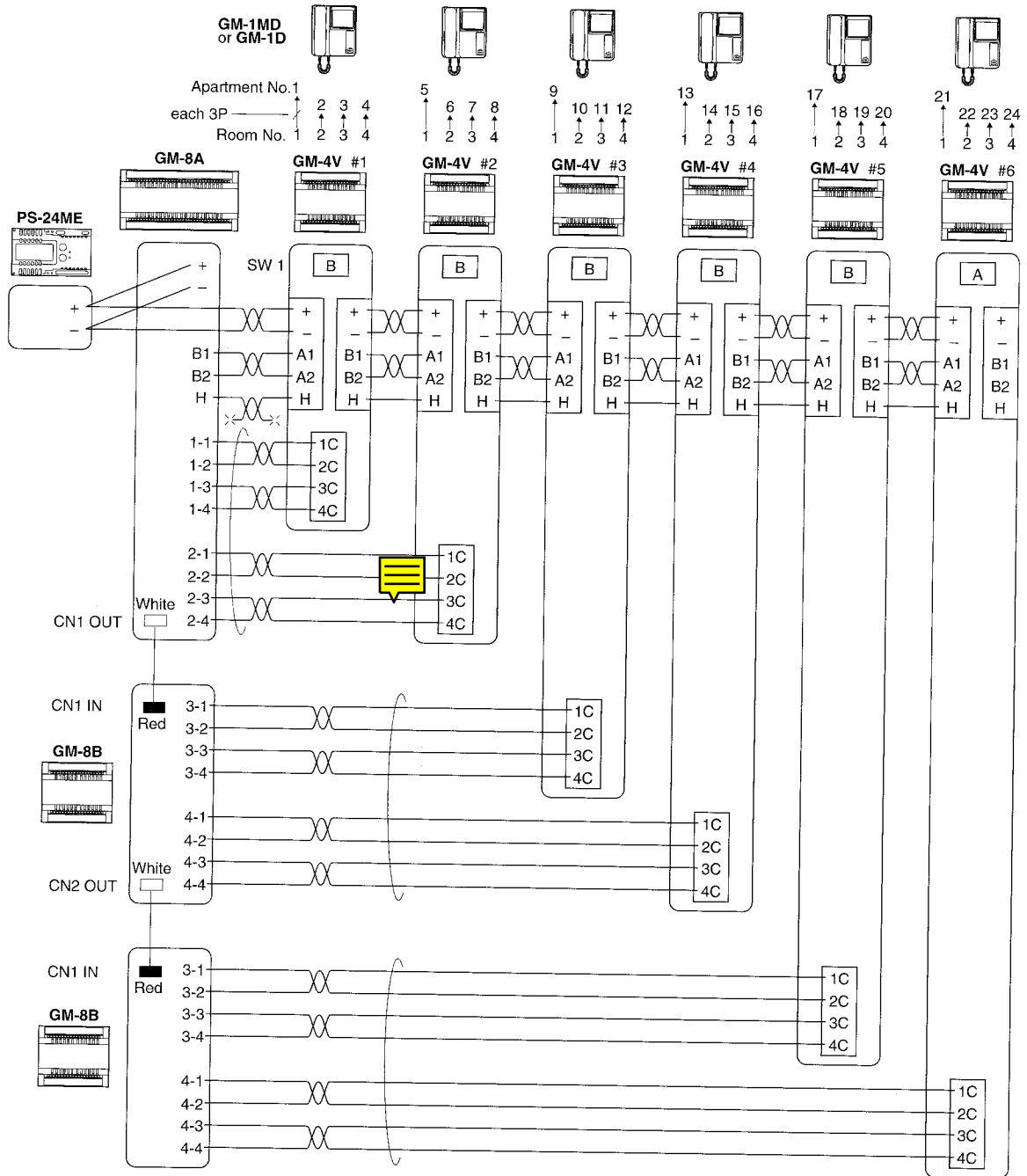

The above diagram shows correlations between Apartment No. & terminals designated.

WIRING DIAGRAMS

● Apartment stations

1.

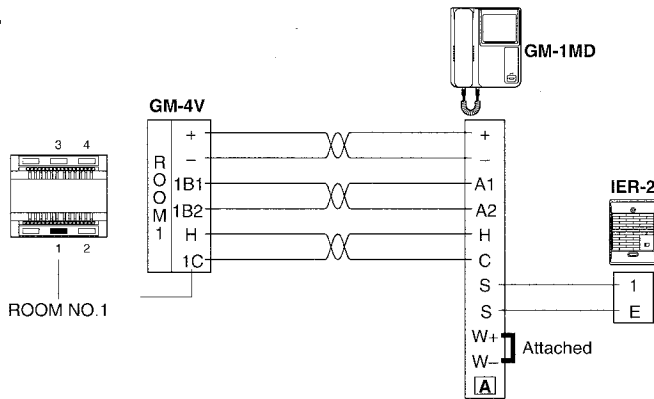

IMPORTANT : Setting on stations per apartment

- ① Shorting link on W+/W-;
 Single station (either) : Must remain attached.
 Two stations (either) : Remove a link on both.
- ② Impedance matching SW1 (GM-1MD only);
 Single monitor (*) : Must remain in A.
 Two monitors : Set to B on first monitor only.
 (*)with or without GM-1D audio-only station.

2.

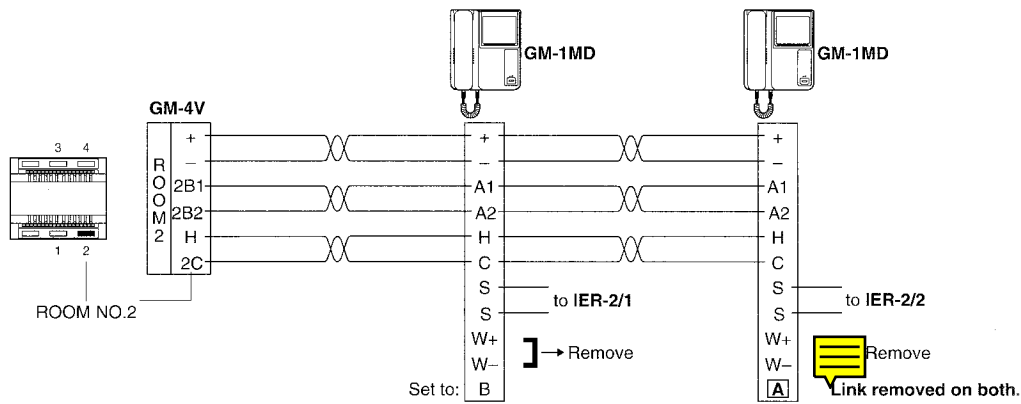

3.

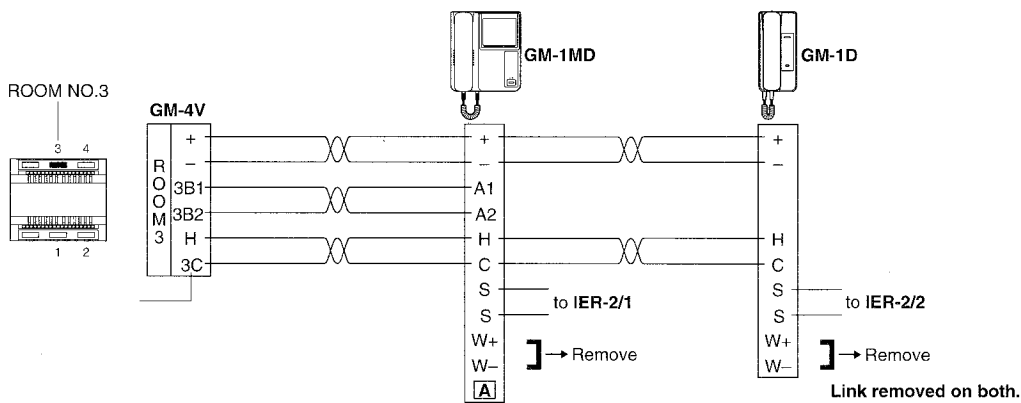

4.

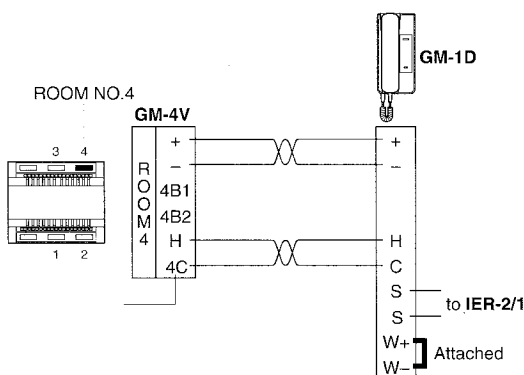

5.

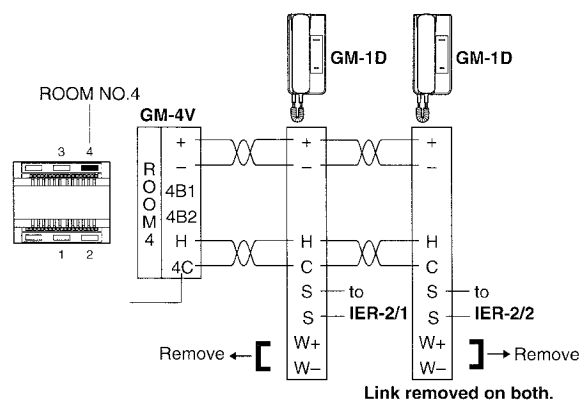

4 MOUNTING

Apartment station

1. Attach the mounting bracket (supplied) to box or wall with 2 screws.
2. Mount GM monitor or audio station on the prongs of the bracket, aligning at the marks.
Pull down the unit until it locks firmly.

■ GM-1MD

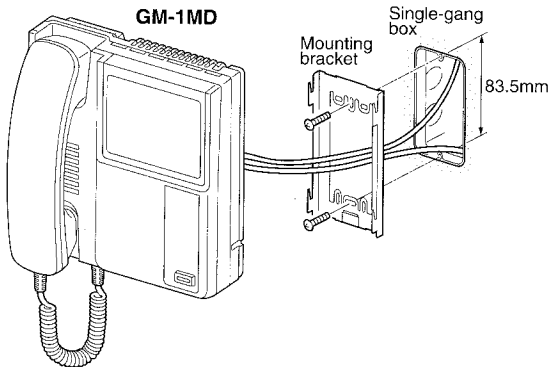

■ GM-1D

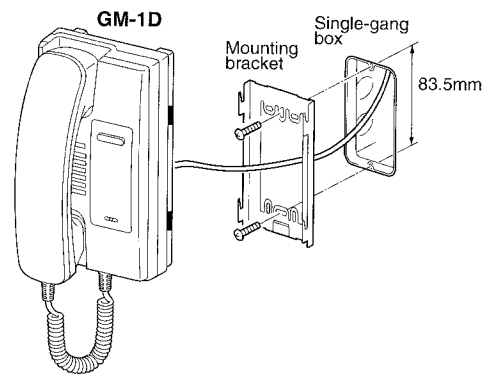

■ IER-2

IER-2 speaker box mounts directly on box or wall with supplied screws.

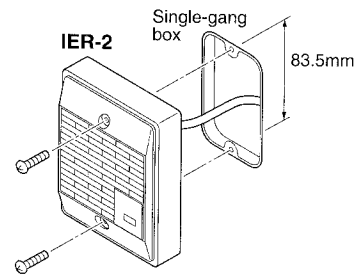

Control units

■ GM-8A, GM-8B & GM-4V

1. Hang on GM unit on DIN rail installed, aligning at the hooks.
2. Push on the bottom of unit, and it will click to lock.
3. As shown below, to remove, pull down the bottom lever using a screwdriver, and the GM unit will unlock.

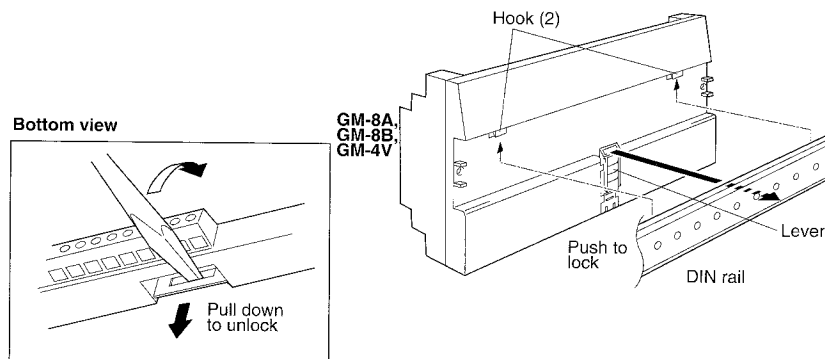

4. MOUNTING

Entrance station

■ Semi-flush mounting in the wall

1. As shown, cut out a hole for GW-2 or GW-3('s) back box(es) in the wall.

BACK BOX DIMENSIONS

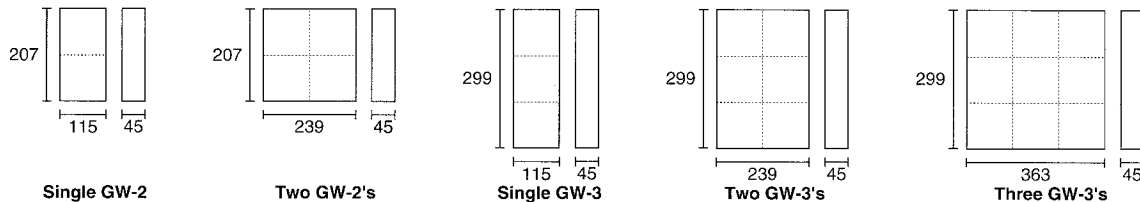

* Box mounting hole should allow 2mm space on each side.

2. Mounting single GW-3 Frame

1. Cut and open a cable pass hole on either side of boxes.
2. Mount the camera, speech & switch modules to the section of GW-2 or GW-3 frame, inserting the stopper on the left.
3. Mount the Frame to Back box with 2 screws (supplied with frame).
4. Place two black covers for mounting screws on top and bottom of Frame.

(*1) supplied with GW-2 or 3 frame.

(*2) GW-VP + GW-V and GW-DP + GW-D :
The module is mounted on the back of panel with 4 screws.

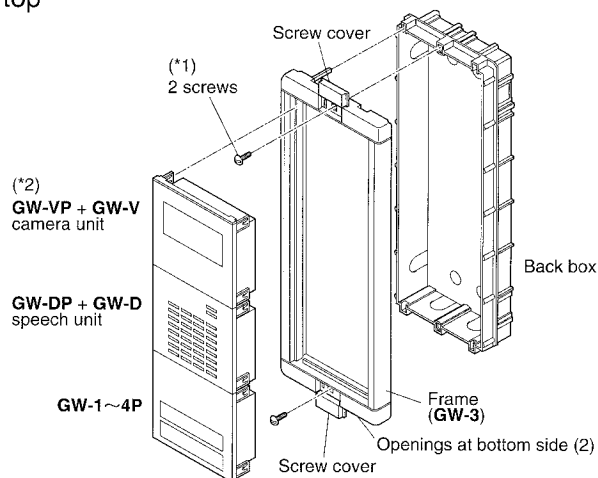

3. Mounting two GW-2 or GW-3 Frame

As shown, unite two or three GW-2 or GW-3 Frames, using 2 joint parts SMALL or LARGE.

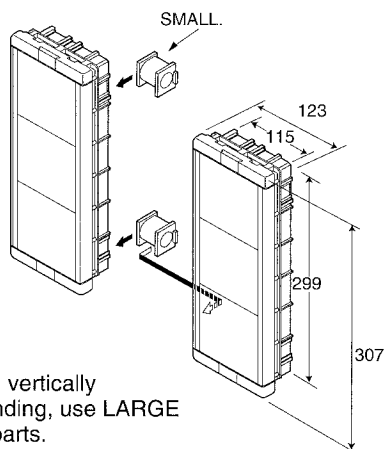

★ When vertically expanding, use LARGE joint parts.

■ Filling in directories

As per Instructions pull the opener off, and the cover is removed. The opener is supplied with GW-2 or GW-3 Frames.

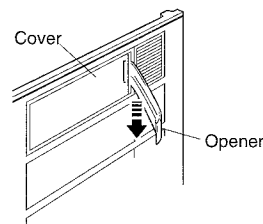

4. MOUNTING

■ Semi-flush mounting (with Hood)

For outside entry, additionally install an optional Hood (GW-nH) in between GW-2 or GW-3 Frame(s) & back boxes.

Models	Description	Dimensions D top (bottom)
GW-002H	Hood for single GW-2	232H x 142W x 43 (23)D
GW-202H	Hood for two GW-2's	232H x 266W x 43 (23)D
GW-003H	Hood for single GW-3	324H x 142W x 43 (23)D
GW-203H	Hood for two GW-3's	324H x 266W x 43 (23)D
GW-303H	Hood for three GW-3's	324H x 390W x 43 (23)D

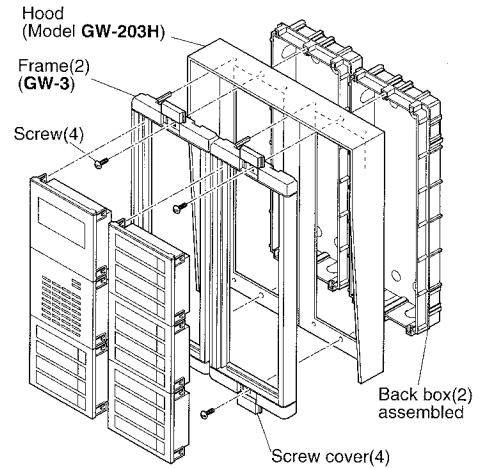

■ Surface-mounting (with Hooded Box)

GW-nHB Surface-mount Box with Hood is shipped complete with GW-2 or GW-3 frame.

Models	Description	Dimensions D top (bottom)
GW-002HB	Boxed hood for single GW-2	232H x 142W x 90 (50)D
GW-202HB	Boxed hood for two GW-2's	232H x 266W x 90 (50)D
GW-003HB	Boxed hood for single GW-3	324H x 142W x 90 (50)D
GW-203HB	Boxed hood for two GW-3's	324H x 266W x 90 (50)D
GW-303HB	Boxed hood for three GW-3's	324H x 390W x 90 (50)D

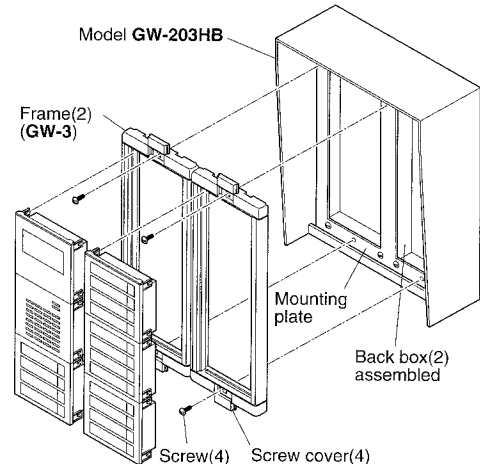

■ PS-24ME power supply

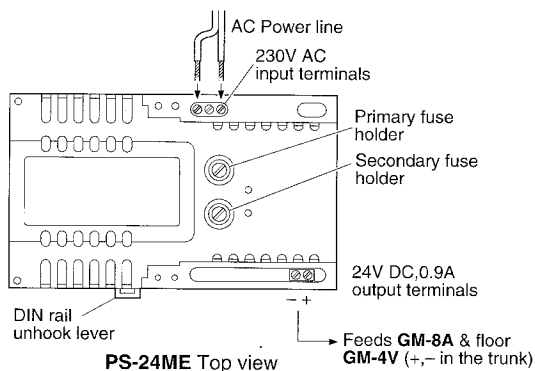

★ **IMPORTANT** – When a supplementary PS-24ME is installed for Trunk line, do not connect + to + terminals on two power supplies.

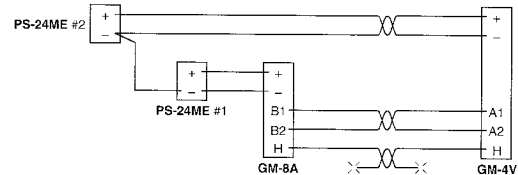

- After wiring, mount a protective cover for each AC & DC wires.
- When DIN rail is not provided, mount PS-24ME with 4 screws to wall.

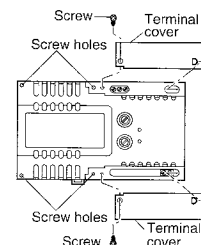

5 OPERATIONS GM SYSTEM

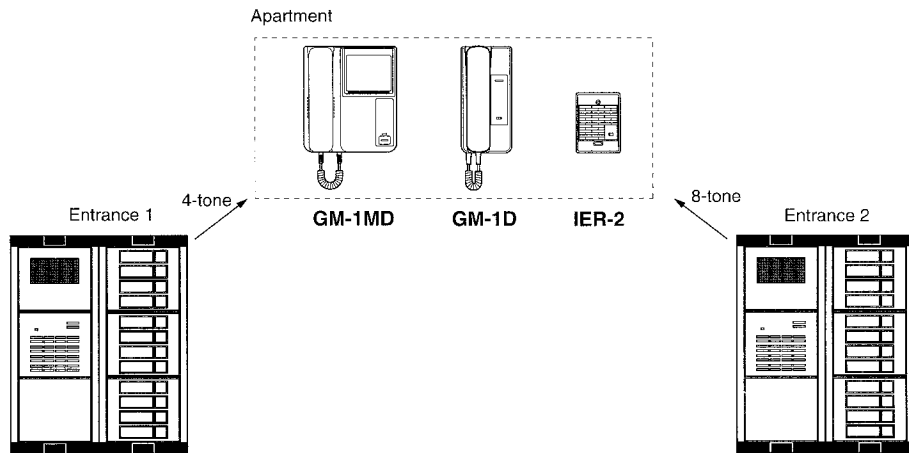

- **On Entrance call panel**
Directories are backlit on the panel. Push an Apartment call button. A muted chime tone is heard at the Entrance. After the apartment station replies, talk hands free in front of the camera.
- * In a 2-entrances system, the Occupied LED is lit on the panels, blocking out a call at the other Entrance.
- **On an apartment station(s)**
Call-in activates 4-tone chime and monitor turns on with image. It times out in 45 seconds. IER-2 speaker(s) also sounds 4-tone chime.
* 8-tone chime is call from the Second Entrance station.
- **Communication**
To reply, lift handset on (either) apartment station. Communicate with a caller at the Entrance. When hearing the other station answering, hang up handset. Communication is terminated when both stations replace handsets, or times out in 2-1/2 minutes.
* There is no calling between apartment stations.
- **Activating door strike**
While an image is on the GM-1MD monitor or audio communication is held on GM-1D handset, depress and hold down Key-mark button. Door strike takes place at communicating entrance.
- **Adjustments on room stations**
BRIGHT: 3 positions to view dim entry.
TONE: 3 positions to hear chime tone properly.

6 TECHNICAL PRECAUTIONS

Temperature	GM Entrance station: $-10^{\circ}\text{C} \sim +60^{\circ}\text{C}$ ($+14^{\circ}\text{F} \sim +140^{\circ}\text{F}$) GM-8A/8B, GM-4V, GM-1MD/1D: $0^{\circ}\text{C} \sim +40^{\circ}\text{C}$ ($+32^{\circ}\text{F} \sim +104^{\circ}\text{F}$). * When the outside temperature lowers rapidly, the camera lens may fog up slightly, causing a blurry picture at the inside monitor.
Mounting locations	GM Entrance call panel is weather-resistant, but for best results, it should be protected from direct weather conditions. Install a hood to protect it from direct rainfall (See illustration on page 21).
For lighting conditions	GW-V camera infrared illumination will light the image of the caller when positioned within 50cm in front of the camera, and will see in near darkness (1 Lux of light).
Wire terminations on GM-8A, GM-8B & GM-4V	Specify the same gauge of wires for trunkage wiring. If the different gauge is employed, it is possible that wire terminations would become loose on terminals when more than 2 wires are connected.
When Audio-Only Entrance Station is installed	Audio-Only Entrance Station must be connected to terminals assigned for Entrance No.2 on GM-8A Main Control Unit. Audio/Video Entrance Station can be connected to either terminals assigned for Entrance No.1 or No.2.
Directory cover opener (GW-1~4P) & Tamper-proof screwdriver (GW-2, 3)	These tools must be kept at the owner or administration company. They will be used when servicing on Entrance station.
Shorting link on Apartment station	Only when two apartment stations are installed, check if shorting link has been removed on BOTH stations, whichever the type is.
Apartment stations numbers	If an apartment station is not yet installed or connected, do not connect the corresponding terminal(s) when wiring between GM-8A and GW-1~4P call switch module.
Operations	At end of communication, be sure to hang up handset on cradle. If a handset is off the hook, it will block out the call signal at two stations. But for approx. 45 sec. after called, the inside audio is activated and heard at the entrance. To resume communication, momentarily hang up handset.
Door release activation	Key-mark button is operative while an image is on the monitor at GM-1MD station, at GM-1D station, after entering communication.
Cleaning	Clean GM equipment with a soft cloth dampened with neutral household cleanser. Never use any abrasive cleaner or cloth.

7 SPECIFICATIONS (GM system)

- Power source: DC 24V, 0.9A (max. 1.26A to power two GM-1MD's)
- Current consumption: Max. 360mA(GM-8A). Max. 80mA(GM-4V).
Max. 410mA (GM-1MD). Max. 50mA (GM-1D).
- Power supply: One PS-24ME to GM-8A (& a second PS-24ME for apartment trunk only when two GM-1MD's are used in a same apartment) or use one PS-24E for any configuration.
- Station capacity: 1 to max. 24 apartments.
- No. of Entrance stations: One or two Entrance panels as follows;
 1. One panel, audio/video
 2. Two panels, audio/video
 3. Two panels, one each audio/video and audio-only
- Apartment stations: One or two stations within an apartment as follows;
 1. One monitor/audio station
 2. Two monitor/audio stations
 3. One each monitor/audio and audio-only station
 4. One audio-only station
 5. Two audio-only stations
- Call extension: One IER-2 per apartment station.
- Communication: Single and non-open channel
- Door release contact capacity: AC 12V, 0.4A (dry closure contact EL1, EL1 and EL2, EL2)
- GW-V camera: Infrared CCD camera
- GM-1MD monitor: 4 inch direct view flat CRT
- Scanning lines: 625 lines
- Wiring: Use twisted pair cable for any (video) wiring.

(to Entrance) GM-8A to GW-V camera: 2P
to GW-D speech: 2P
to GW-1~4P call switch: 4 common wires + 1 per call switch panel

(to Apartment) GM-8A to GM-4V distributor: 5 (3P) + no. of apartments
★ GM-8B has only 8 individual call terminals.

GM-4V to GM-1MD: 3P
to GM-1D: 2P
Apartment station to IER-2: 2 wires

* For directories backlighting lamp & door release, run each separate cable from GM audio/video cable.

- Wiring distance:

Diameter	0.65mmø	1.0mmø
Entrance to Apartment	50m	100m
Entrance to GM-8A	8m	20m
PS-24ME to GM-8A	8m	20m

This equipment has been tested and found to comply with the limits for a Class B digital device, pursuant to Part 15 of the FCC Rules. These limits are designed to provide reasonable protection against harmful interference in a residential installation. This equipment generates, uses, and can radiate radio frequency energy and, if not installed and used in accordance with the instructions, may cause harmful interference to radio communications. However, there is no guarantee that interference will not occur in a particular installation. If this equipment does cause harmful interference to radio or television reception, which can be determined by turning the equipment off and on, the user is encouraged to try to correct the interference by one or more of the following measures:

- Reorient or relocate the receiving antenna.
- Connect the equipment into an outlet on a circuit different from that to which the receiver is connected.
- Increase the separation between the equipment and receiver.
- Consult the dealer or an experienced radio/TV technician for help.

WARRANTY

Aiphone warrants its products to be free from defects of material and workmanship under normal use and service for a period of two years after delivery to the ultimate user and will repair free of charge or replace at no charge, should it become defective upon which examination shall disclose to be defective and under warranty. Aiphone reserves unto itself the sole right to make the final decision whether there is a defect in materials and/or workmanship; and whether or not the product is within the warranty.

This warranty shall not apply to any Aiphone product which has been subject to misuse, neglect, accident, or to use in violation of instructions furnished, nor extended to units which have been repaired or altered outside of the factory. This warranty does not cover batteries or damage caused by batteries used in connection with the product.

This warranty covers bench repairs only, and any repairs must be made at the shop or place designated in writing by Aiphone.

Aiphone will not be responsible for any costs incurred involving on site service calls.